



**Business Requirements  
for  
Alignment of Accounting  
Point characteristics**

Status: Approved by ebIX® Forum

Version: 3.1

Revision: B

Date: November 2023

Content

- A. ABOUT THIS DOCUMENT .....4**
- A.1. REFERENCES .....5**
- A.1.1. STANDARDS .....5**
- A.1.2. EBIX® DOCUMENTS .....5**
- A.2. MAIN CHANGES SINCE LAST VERSION .....5**
- 1 INTRODUCTION .....7**
- 1.1 DEFINITIONS ..... 7
- 2 BUSINESS DOMAIN VIEW: ALIGNMENT OF ACCOUNTING POINT CHARACTERISTICS .....9**
- 2.1 ALIGN ACCOUNTING POINT CHARACTERISTICS (BUSINESS PROCESS USECASE)..... 9
  - 2.1.1 *Description*..... 9
  - 2.1.2 *Business Domain View: Request Accounting Point characteristics (Business Process UseCase)*..... 10
  - 2.1.3 *Business Domain View: Change Accounting Point characteristics (Business Process UseCase)*..... 13
- 3 BUSINESS PARTNER VIEW .....25**
- 3.1 BUSINESS PARTNERS RELATED TO ALIGNMENT OF ACCOUNTING POINT CHARACTERISTICS ..... 25
- 4 BUSINESS ENTITY VIEW .....26**
- 4.1 ACCOUNTING POINT CHARACTERISTICS (CLASS DIAGRAM) ..... 27
  - 4.1.1 *Element definitions: Accounting Point characteristics* ..... 28
- 4.2 REQUEST ACCOUNTING POINT CHARACTERISTICS (CLASS DIAGRAM)..... 34
  - 4.2.1 *Element definitions: Request Accounting Point characteristics* ..... 34
- 4.3 REJECT REQUEST ACCOUNTING POINT CHARACTERISTICS (CLASS DIAGRAM)..... 36
  - 4.3.1 *Element definitions: Reject request Accounting Point characteristics* ..... 36
- 4.4 REQUEST CHANGE ACCOUNTING POINT CHARACTERISTICS BY GRID COMPANY (CLASS DIAGRAM) ..... 38
  - 4.4.1 *Element definitions: Request change Accounting Point characteristics by Grid Company* .. 39
- 4.5 CONFIRM REQUEST CHANGE ACCOUNTING POINT CHARACTERISTICS BY GRID COMPANY (CLASS DIAGRAM) . 45
  - 4.5.1 *Element definitions: Confirm request change Accounting Point characteristics by Grid Company*..... 46
- 4.6 REJECT REQUEST CHANGE ACCOUNTING POINT CHARACTERISTICS BY GRID COMPANY (CLASS DIAGRAM) .... 52
  - 4.6.1 *Element definitions: Reject request change Accounting Point characteristics by Grid Company*..... 53
- 4.7 REQUEST CHANGE ACCOUNTING POINT CHARACTERISTICS BY ENERGY SUPPLIER (CLASS DIAGRAM) ..... 57
  - 4.7.1 *Element definitions: Request change Accounting Point characteristics by Energy Supplier* 58
- 4.8 CONFIRM REQUEST CHANGE ACCOUNTING POINT CHARACTERISTICS BY ENERGY SUPPLIER (CLASS DIAGRAM) 59
  - 4.8.1 *Element definitions: Confirm request change Accounting Point characteristics by Energy Supplier*..... 60
- 4.9 REJECT REQUEST CHANGE ACCOUNTING POINT CHARACTERISTICS BY ENERGY SUPPLIER (CLASS DIAGRAM) .. 61

- 4.9.1 *Element definitions: Reject request change Accounting Point characteristics by Energy Supplier*..... 62
- 4.10 REQUEST UPDATE ACCOUNTING POINT CHARACTERISTICS (CLASS DIAGRAM) ..... 63
  - 4.10.1 *Element definitions: Request update Accounting Point characteristics* ..... 64
- 4.11 CONFIRM REQUEST UPDATE ACCOUNTING POINT CHARACTERISTICS (CLASS DIAGRAM) ..... 67
  - 4.11.1 *Element definitions: Confirm request update Accounting Point characteristics* ..... 68
- 4.12 REJECT REQUEST UPDATE ACCOUNTING POINT CHARACTERISTICS (CLASS DIAGRAM) ..... 71
  - 4.12.1 *Element definitions: Reject request update Accounting Point characteristics* ..... 72

**APPENDIX A. HEADER AND CONTEXT INFORMATION FOR THE CLASS DIAGRAMS ..... 73**

- A.1. HEADER AND CONTEXT INFORMATION ATTRIBUTES DEFINITIONS ..... 73
- A.2. ACCOUNTING POINT CHARACTERISTICS ..... 73
- A.3. REQUEST ACCOUNTING POINT CHARACTERISTICS..... 74
- A.4. REJECT REQUEST ACCOUNTING POINT CHARACTERISTICS ..... 74
- A.5. REQUEST UPDATE ACCOUNTING POINT CHARACTERISTICS ..... 75
- A.6. CONFIRM REQUEST UPDATE ACCOUNTING POINT CHARACTERISTICS ..... 75
- A.7. REJECT REQUEST UPDATE ACCOUNTING POINT CHARACTERISTICS ..... 76
- A.8. REQUEST CHANGE ACCOUNTING POINT CHARACTERISTICS BY GRID COMPANY ..... 76
- A.9. CONFIRM REQUEST CHANGE ACCOUNTING POINT CHARACTERISTICS BY GRID COMPANY..... 77
- A.10. REJECT REQUEST CHANGE ACCOUNTING POINT CHARACTERISTICS BY GRID COMPANY ..... 77
- A.11. REQUEST CHANGE ACCOUNTING POINT CHARACTERISTICS BY ENERGY SUPPLIER..... 78
- A.12. CONFIRM REQUEST CHANGE ACCOUNTING POINT CHARACTERISTICS BY ENERGY SUPPLIER ..... 78
- A.13. REJECT REQUEST CHANGE ACCOUNTING POINT CHARACTERISTICS BY ENERGY SUPPLIER..... 79

## A. About this document

This document is a Business Requirements Specification (BRS) for Alignment of Accounting Point (AP) characteristics within the structuring process of the European energy market. In this BRS we use business terms for the actors, and we map them to the terms used in the Harmonised Role Model from ENTSO-E, ebIX® and EFET [2]. A party acts in the capacity of a certain role.

In the Harmonised Role Model, a Metering Point may be a Metering Point or an Exchange Point. This BRS is limited to the alignment of Accounting Point characteristics. The alignment of Exchange Points characteristics will be specified in a separate BRS.

The alignment of Accounting Point characteristics consists of several sub processes:

- The Metering Point Administrator administrates the Accounting Points and its characteristics.
- After a change of the characteristics of the Accounting Point, the Metering Point Administrator will notify all Linked Parties, such as the Energy Supplier and Balance Responsible Party, and Consented Parties to the Accounting Point of the change.
- Linked- or Consented Parties to the Accounting Point can request Accounting Point characteristics. It is a prerequisite that the requesting party is authorised, i.e. is properly consented, to receive Accounting Point characteristics. Contrary to the “Consented request for Accounting Point characteristics”, see [10], the request Accounting Point characteristics process described in his BRS may return all Accounting Point characteristics elements the requesting party may need to fulfil its obligations in the energy market.
- The Change Accounting Point characteristics process is a process where a Content Responsible Party requests changes to the characteristics of an Accounting Point. In a supplier centric environment, there are two Content Responsible Parties for each Accounting Point, being responsible for different sets of the Accounting Point characteristics. I.e. the responsibility is split between the Grid Company and the Energy Supplier.
- As most of the characteristics is Grid Company responsibility, some of the characteristics can be requested updated by a third party to the Grid Company.

**Example:**

- The Metered Data Responsible or Energy Supplier can ask the Grid Company to update the Accounting Point address. After the Grid Company has accepted the update, he will request the Metering Point Administrator to change the Accounting Point characteristics.

The lifecycle of an Accounting Point, including how the Grid Company can create, activate, deactivate and/or decommission an Accounting Point, is described in the BRS for Manage Accounting Points, see [8].

Note that Accounting Point characteristics (master data) should not be cancelled but updated.

As a general introduction ebIX® has published a separate document “Introduction to ebIX® Business Requirements and Business Information Models” [4]. The introduction also includes the generic model elements that are not specific for a business process.

In line with UN/CEFACT Modelling Methodology version 2 (UMM-2) ebIX® defines the business requirements as the first step in modelling energy market processes. This document specifies an UMM

Business Requirements View, which consist of the three sub views: Business Domain View, Business Partner View and Business Entity View.

The Business Information Model is in turn the basis for the creation of XML schema’s and is the basis for the specification of web services. The Business Information Model and the syntax specific structures are specified by the “ebIX® Technical Committee” (ETC).

Since the ebIX® model is open for national customisation, some attributes are added as optional for usage for regional/national customisation. If used, these attributes must be specified nationally.

## A.1. References

### A.1.1. Standards

- [1] UML Profile for UN/CEFACT’s Modelling Methodology (UMM), Base Module 2.0., (<http://www.unece.org/tradewelcome/un-centre-for-trade-facilitation-and-e-business-uncefact/outputs/technical-specifications/uncefact-modelling-methodology-umm.html>);
- [2] UML Profile for UN/CEFACT’s Modelling Methodology (UMM), Foundation Module, 2.0. (<http://www.unece.org/tradewelcome/un-centre-for-trade-facilitation-and-e-business-uncefact/outputs/technical-specifications/uncefact-modelling-methodology-umm.html>);
- [3] The Harmonized Role Model (for the Electricity Market) by ebIX®, ENTSO-E, and EFET ([www.ebix.org](http://www.ebix.org)).

### A.1.2. ebIX® Documents

- [4] Introduction to ebIX® Business Requirements and Business Information Models ([www.ebix.org](http://www.ebix.org));
- [5] Recommended Identification Schemes for the European Energy Market ([www.ebix.org](http://www.ebix.org));
- [6] ebIX® code lists ([www.ebix.org](http://www.ebix.org));
- [7] ebIX® BRS for Measure for Determine Meter Read ([www.ebix.org](http://www.ebix.org));
- [8] ebIX® BRS for Manage Accounting Points ([www.ebix.org](http://www.ebix.org));
- [9] ebIX® BRS for administration of consent ([www.ebix.org](http://www.ebix.org));
- [10] ebIX BRS for consented request for Accounting Point characteristics ([www.ebix.org](http://www.ebix.org)).

## A.2. Main changes since last version

Old	New	Clarification	Date
<b>Version 4.3</b>			
4.2.A	4.3.A	<ul style="list-style-type: none"> <li>• Rename of the class “Reconciliation information” to “Energy volume information” to the Accounting Point characteristics</li> </ul>	20230208

Old	New	Clarification	Date
		<p>document, the Request change Accounting Point characteristics by Grid Company document and Confirm request change Accounting Point characteristics by Grid Company document.</p> <ul style="list-style-type: none"> <li>• Addition of attribute “Consumption detail” to “Energy volume information” class to the Accounting Point characteristics document, the Request change Accounting Point characteristics by Grid Company document, Confirm request change Accounting Point characteristics by Grid Company document and Reject request change AP characteristics by Grid Company document.</li> <li>• Addition of Accounting Point level and Grid Connection ID to the Accounting Point characteristics document, the Request change Accounting Point characteristics by Grid Company document and Confirm request change Accounting Point characteristics by Grid Company document.</li> <li>• Addition of Metered Data Administrator ID and Metering Point Administrator ID to the Accounting Point characteristics document.</li> <li>• Addition of clarifying text in the introduction related to Grid connection ID and sub-Accounting Points.</li> </ul>	
4.3.A	4.3.B	<ul style="list-style-type: none"> <li>• Update of definitions of Aggregated Reception Station and Calorific Value Area.</li> </ul>	20230815
4.3.A	4.3.C	<ul style="list-style-type: none"> <li>• Since ebIX® is closing down from the end of 2023, the link to the ebIX® secretary has been removed.</li> </ul>	20231128
<b>Version 4.2</b>			
4.1.A	4.2.A	<ul style="list-style-type: none"> <li>• Addition of Flexibility Register Administrator to Request Accounting Point characteristics (Business Process UseCase)</li> <li>• Addition of clarifying text and correction of spelling errors.</li> <li>• Restructuring of class diagram for Accounting Point characteristics, including:                             <ul style="list-style-type: none"> <li>○ Removal of “Meter Reading Periodicity”</li> <li>○ Addition of a new class “Measurement information” containing the following new attributes:                                     <ul style="list-style-type: none"> <li>○ Addition of “Reporting Interval”</li> <li>○ Addition of “Reporting Resolution”</li> <li>○ Addition of “Register resolution”</li> </ul> </li> </ul> </li> </ul>	20221019
<b>Version 4.1</b>			
4.0.C	4.1.A	Addition of Check consent process.	20201019
<b>Version 4.0</b>			
4.0.A	4.0.B	Alignment of UseCase structure with BRS for Alignment of Metering Configuration Characteristics, correction of spelling errors and addition of clarifying text.	20200519

Old	New	Clarification	Date
4.0.B	4.0.C	Correction of typing errors.	20200826

## 1 Introduction

### 1.1 Definitions

- The Accounting Point is a representation of a connection to the physical grid, hence there may be a “Grid connection ID” assigned to the Accounting Point. An Accounting Point can in rare cases have multiple connections to the grid (typically for large industries).

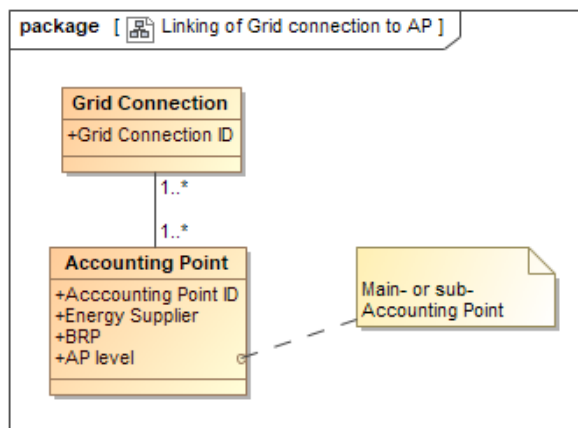

The Grid connection may be called “Head Point” (e.g. Belgium) or “Net (Grid) Location Point” (e.g. Germany).

- From each (main) Accounting Point it may be split off one or more sub-Accounting Point(s), which is/are measured. The sub-Accounting Points must be treated as normal Accounting Points (APs) in the market processes.

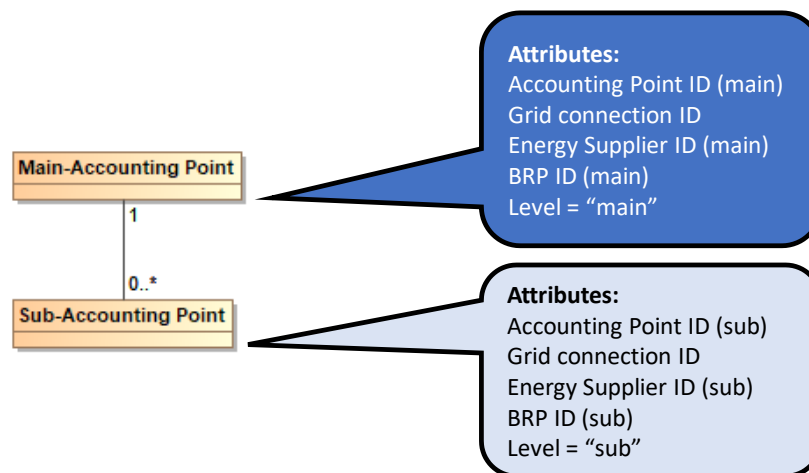

One of the Accounting Points must be entitled as the “main-Accounting Point”, which is responsible for the connection to the grid. Therefore we introduce the attribute “Accounting Point level” to indicate main- or sub-Accounting Point.

A move-out of the main-Accounting point may, based on national rules, result in the end of contract for all related sub-Accounting Points.

Depending on the physical placement of the meters for the Accounting Points, there may be a dependency for the determining of the volumes for each Accounting Point.

Main Accounting Point may be called “Primary Accounting Point”, “Master Accounting Point” or “Parent Accounting Point”. Sub-Accounting Point may be called “Secondary Accounting point”, “Slave Accounting point” or “Child Accounting point”.



## 2 Business Domain View: Alignment of Accounting Point characteristics

### 2.1 Align Accounting Point characteristics (Business Process UseCase)

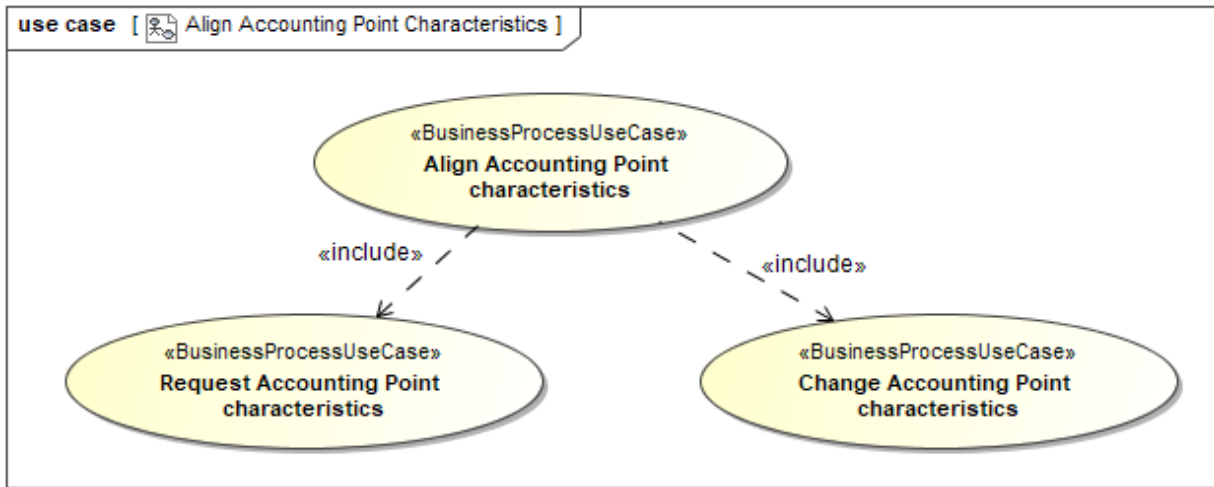

Figure 1 Align Accounting Point characteristics

#### 2.1.1 Description

UseCase description: Align Accounting Point characteristics	
definition	This is the process where a Linked Party, a Consented Party or a Meter Administrator can request Accounting Point characteristics from the Metering Point Administrator or the Content Responsible Party, i.e. Energy Supplier or Grid Company, can request change of one or more of the Metering Point characteristics at the Metering Point administration.
beginsWhen	There is a need for alignment of characteristics of the Accounting Point.
preCondition	There are parties linked to the Accounting Point.
endsWhen	When the Linked Parties, the Consented Parties and the Meter Administrator have received the Accounting Point characteristics.
postCondition	The Accounting Point characteristics are updated and aligned between the Metering Point Administrator and the Linked Parties, the Consented Parties and the Meter Administrator concerned.
exceptions	None.
actions	Not relevant at this level.

### 2.1.2 Business Domain View: Request Accounting Point characteristics (Business Process UseCase)

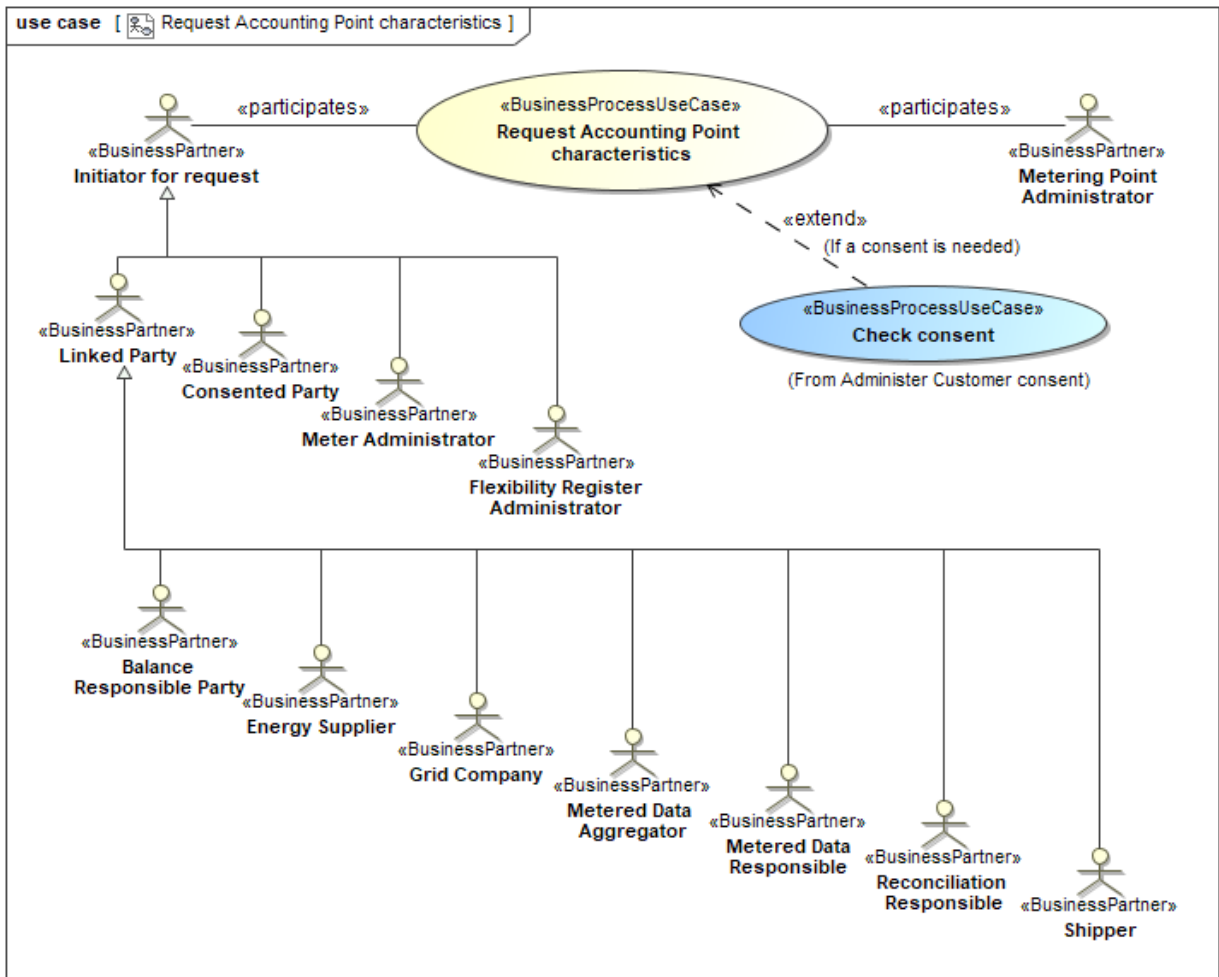

Figure 2 Request Accounting Point characteristics

### 2.1.2.1 Description

UseCase description: Request Accounting Point characteristics <sup>1</sup>	
definition	<p>In this process the Initiator for Request, i.e. a Linked Party:</p> <ul style="list-style-type: none"> <li>• Balance Responsible Party,</li> <li>• Energy Supplier,</li> <li>• Grid Company,</li> <li>• Metered Data Aggregator,</li> <li>• Metered Data Responsible,</li> <li>• Reconciliation Responsible,</li> <li>• Shipper,</li> </ul> <p>Consented Party, Meter Administrator or Flexibility Register Administrator requests Accounting Point characteristics from the Metering Point Administrator for alignment of the Accounting Point characteristics.</p> <p>For Consented Parties, the validity of the consent is checked before the response is sent.</p>
beginsWhen	The Initiator for Request needs to align its Accounting Point characteristics for a specific Accounting Point.
preCondition	<p>The Initiator for Request is linked/known to the Accounting Point.</p> <p>If Accounting Point characteristics are requested by a Linked Party, the requestor must be authorised (implicit consent) to receive Accounting Point characteristics, i.e. that the requestor has a formal responsibility for the Accounting Point, such as an Energy Supplier or a Grid Company.</p>
endsWhen	When the Initiator for Request has received the characteristics of the Accounting Point from the Metering Point Administrator
postCondition	The Initiator for Request has aligned the Accounting Point characteristics for the Accounting Point.
exceptions	The request was rejected by the Metering Point Administrator, e.g. if the Initiator for Request is not allowed access to the data (based on national rules).
actions	See 2.1.2.2

<sup>1</sup> Consented request for Accounting Point characteristics is described in a separate BRS, see [10].

2.1.2.2 Business process

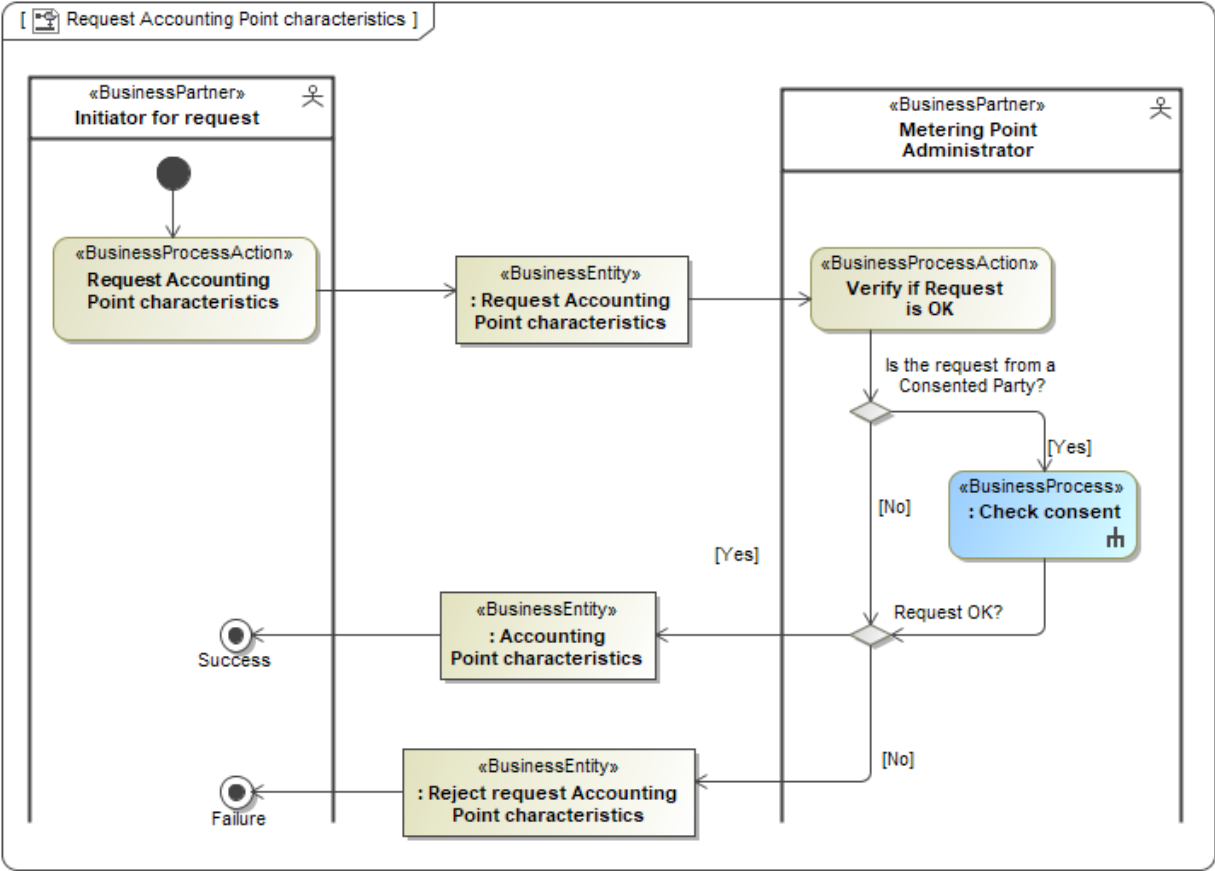

Figure 3 Business Process: Request Accounting Point characteristics

2.1.2.3 Check consent

Before the Metering Point Administrator can give out a specific data set to the requesting Consented Party, he should check with the Consent Administrator whether the Customer involved has given its consent to let a Specific Party retrieve data from the Accounting Point for a specified date or period. This process is described in the ebIX® Business Requirements for administration of consent [9].

### 2.1.3 Business Domain View: Change Accounting Point characteristics (Business Process UseCase)

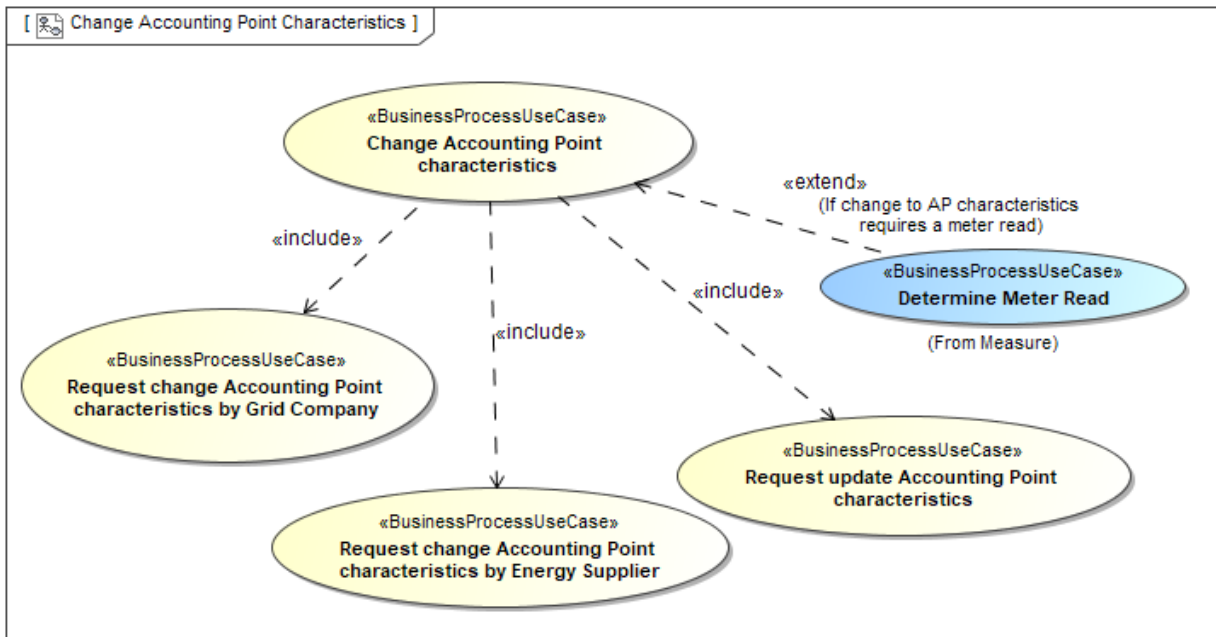

Figure 4 Change Accounting Point characteristics

#### 2.1.3.1 Description

UseCase description: Change Accounting Point characteristics	
definition	<p>This is the process where the Energy Supplier or Grid Company makes changes to relevant Accounting Point characteristics for a specified Accounting Point.</p> <p>After a change, the Metering Point Administrator will notify the Linked Parties, the Consented Parties, the Meter Administrator and the Flexibility Register Administrator of the Accounting Point characteristics.</p> <p>Further, the request for change of Accounting Point characteristics from the Grid Company can be initiated by a request for update from the Energy Supplier or the Metered Data Responsible.</p> <p>Based on national rules and on what is updated, there may be a need to determine a meter read.</p>
beginsWhen	When there is a need to change or update characteristics for the Accounting Point.
preCondition	The Energy Supplier, Metered Data Responsible and/or the Grid Company are linked to the Accounting Point.

endsWhen	<p>When the following are fulfilled:</p> <ul style="list-style-type: none"> <li>• Characteristics have been changed in the Metering Point administration.</li> <li>• All Linked Parties, Consented Parties, the Meter Administrator and the Flexibility Register Administrator have received updated Accounting Point characteristics from the Metering Point Administrator.</li> <li>• If the change of Accounting Point attribute requires a meter read, a Meter read has been determined and exchanged.</li> </ul>
postCondition	All Linked Parties, Consented Parties, the Meter Administrator and the Flexibility Register Administrator have aligned the changed Accounting Point characteristics and, if necessary, a meter read has been distributed.
exceptions	The request to update or change Accounting Point characteristics is rejected.
actions	See 2.1.3.2

2.1.3.2 Business process

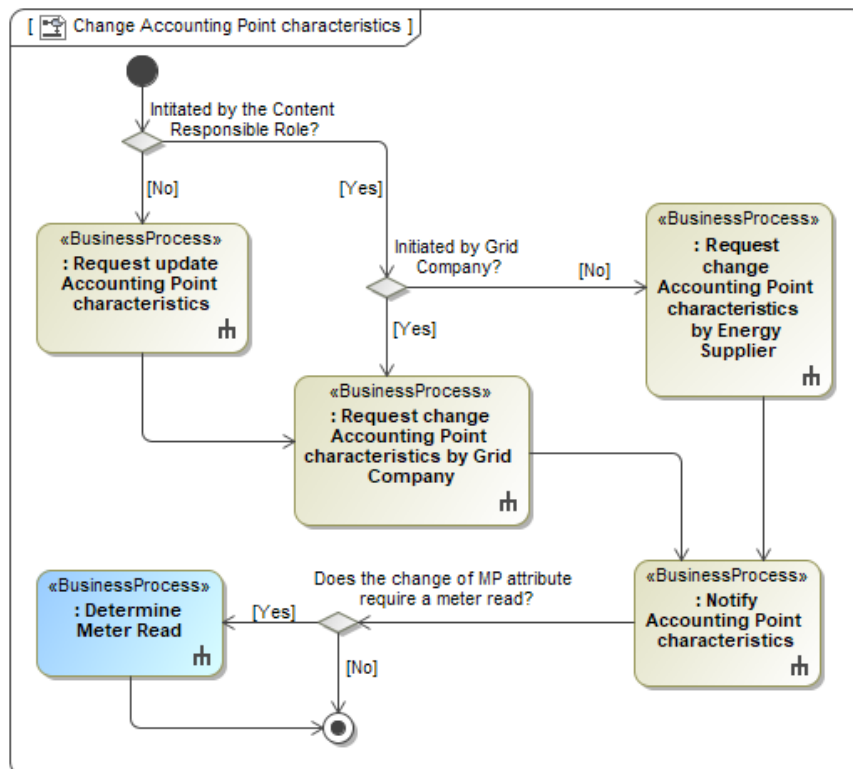

Figure 5 Business Process Change Accounting Point characteristics

**Remark:** Because these are business requirements, the activity diagrams are kept simple. A consequence is that a “failure” in a sub process is seen as an end of the total process.

### 2.1.3.3 Request change Accounting Point characteristics by Grid Company

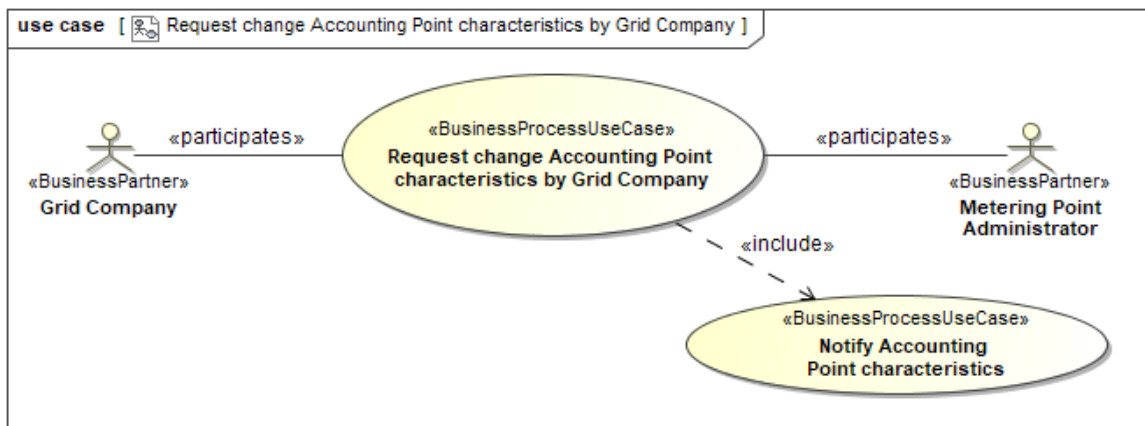

Figure 6 Request Change Accounting Point characteristics by Grid Company

#### 2.1.3.3.1 Description

UseCase description: Request change Accounting Point characteristics by Grid Company	
definition	<p>In this process the Grid Company requests the Metering Point Administrator to change one or more Accounting Point characteristic in the Metering Point administration and the Metering Point Administrator confirms it. Consequently, the Metering Point Administrator will notify the Linked Parties, Consented Parties, the Meter Administrator and the Flexibility Register Administrator of the changed Accounting Point characteristics.</p> <p>The Request change Accounting Point characteristics by Grid Company is a process where almost all attributes from the Accounting Point characteristics can be changed, except:</p> <ul style="list-style-type: none"> <li>• Accounting Point ID and parties.</li> <li>• Administrative status.</li> <li>• Name or ID from the Customer.</li> </ul>
beginsWhen	The Grid Company has the need to change the Accounting Point characteristics, potentially triggered by an accepted request for update of Accounting Point characteristics from the Energy Supplier or the Metered Data Responsible.
preCondition	The Grid Company is responsible for the Accounting Point.
endsWhen	When the change of the Accounting Point characteristics is confirmed by the Metering Point Administrator.
postCondition	The Change Accounting Point characteristics has been confirmed.
exceptions	The request for change of Accounting Point characteristics is rejected.
actions	See 2.1.3.3.2

2.1.3.3.2 Business process

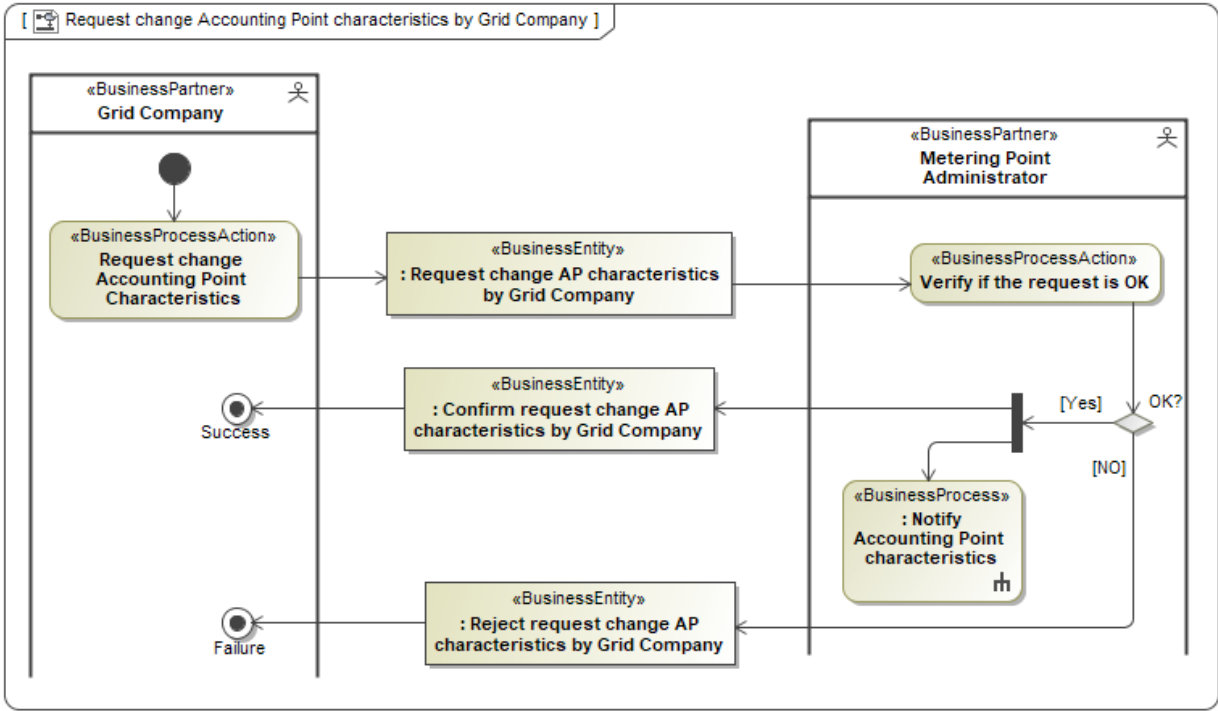

Figure 7 Business Process: Request Change Accounting Point characteristics by Grid Company



### 2.1.3.4 Request change Accounting Point characteristics by Energy Supplier

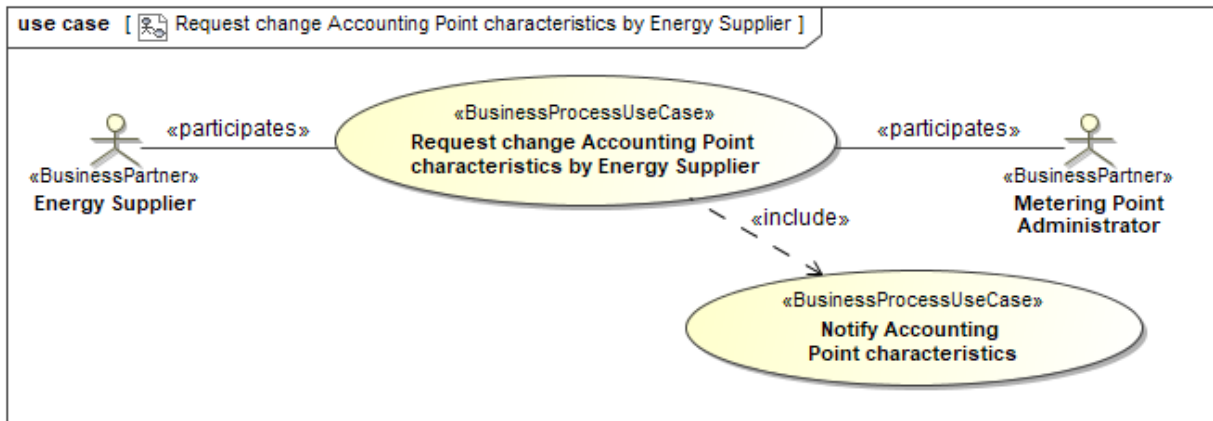

Figure 8 Request Change Accounting Point characteristics by Energy Supplier

#### 2.1.3.4.1 Description

UseCase description: Request change Accounting Point characteristics by Energy Supplier	
definition	<p>In this process the Energy Supplier requests a change of one or more Accounting Point characteristics with the Metering Point Administrator, who confirms it. Consequently, the Metering Point Administrator will notify the Linked Parties, Consented Parties, the Meter Administrator and the Flexibility Register Administrator of the changed Accounting Point characteristics.</p> <p>The Request change Accounting Point characteristics by Energy Supplier is a process where the following attributes can be changed:</p> <ul style="list-style-type: none"> <li>• Customer Name</li> <li>• Customer ID</li> </ul> <p>Note that this process only is used for change of name and/or ID of an existing Customer and cannot be used for moving a new Customer into the Accounting Point.</p>
beginsWhen	When the Energy Supplier has the need to change the Accounting Point characteristics.
preCondition	The Energy Supplier is linked to the Accounting Point.
endsWhen	When the Request Change of Accounting Point characteristics is confirmed by the Metering Point Administrator.
postCondition	The change of the Accounting Point characteristics has been confirmed.
exceptions	The request for change of Accounting Point characteristics is rejected.
actions	See 2.1.3.4.2

2.1.3.4.2 Business process

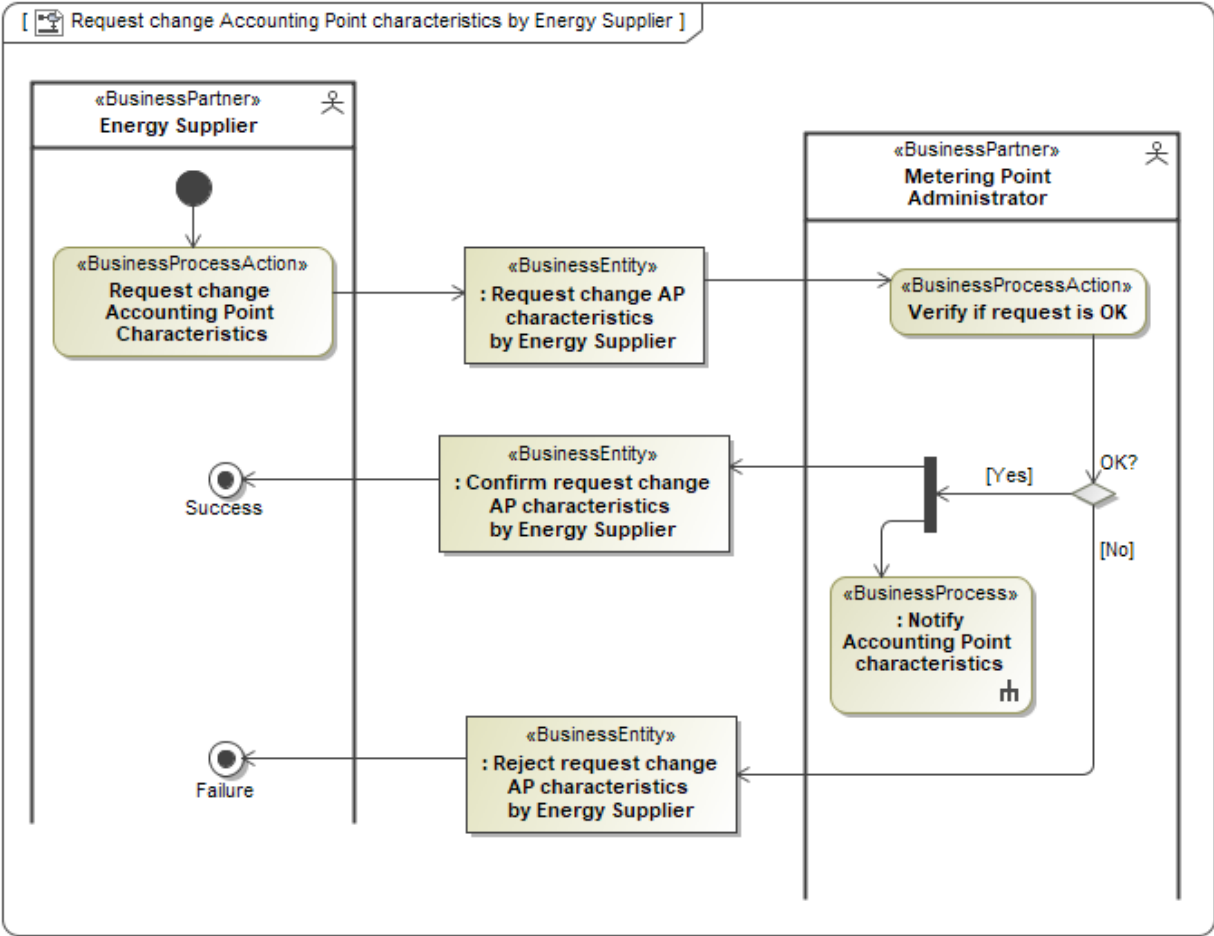

Figure 9 Business Process: Request Change Accounting Point characteristics by Energy Supplier

### 2.1.3.5 Business Domain View: Notify Accounting Point characteristics (Business Process UseCase)

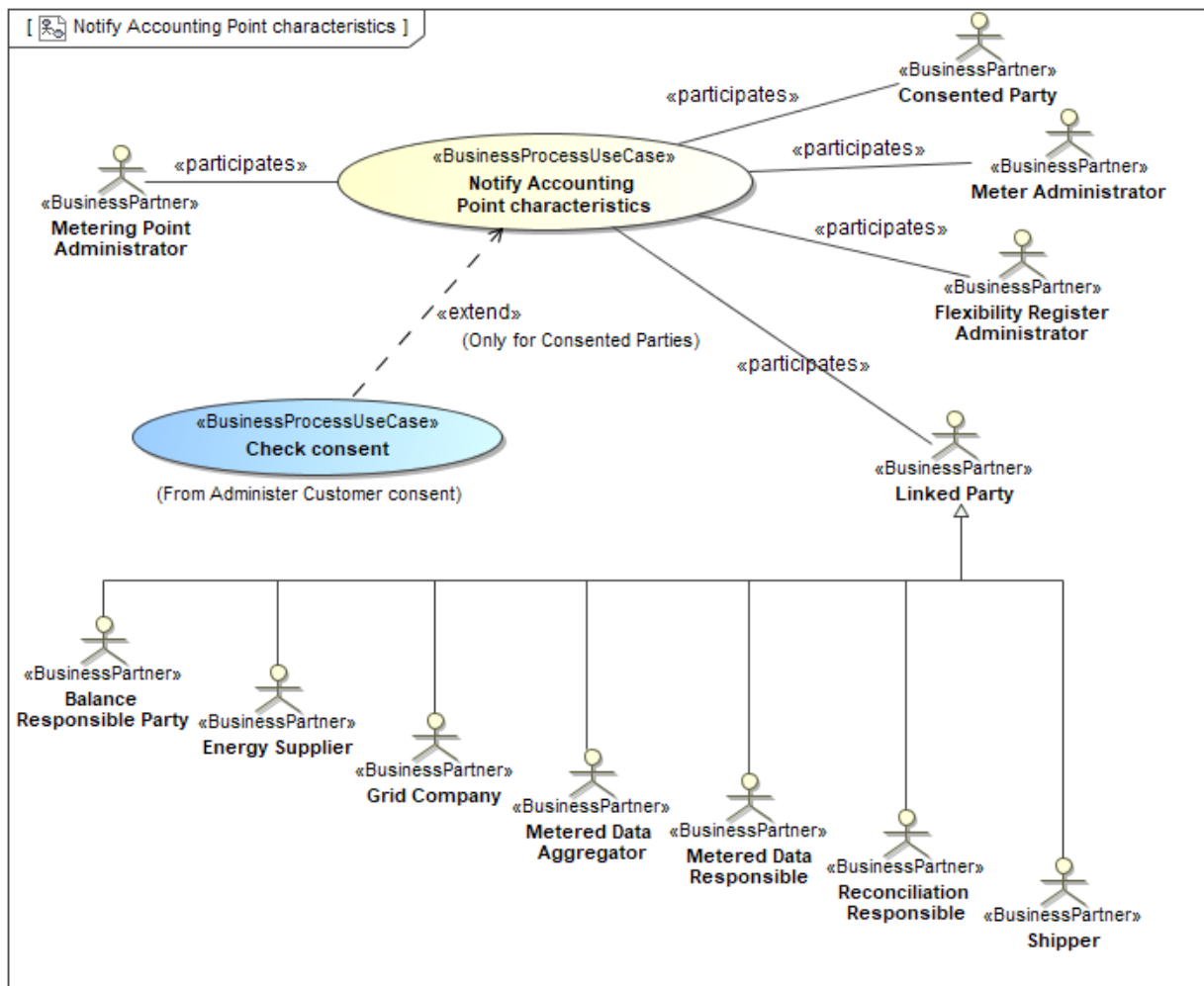

Figure 10 Notify Accounting Point characteristics

#### 2.1.3.5.1 Description

UseCase description: Notify Accounting Point characteristics	
definition	<p>In this process the Metering Point Administrator distributes characteristics of an Accounting Point, after update of one or more of these characteristics of this Accounting Point, to Linked Parties<sup>2</sup> and <sup>3</sup>:</p> <ul style="list-style-type: none"> <li>• Balance Responsible Party,</li> <li>• Energy Supplier,</li> <li>• Grid Company,</li> </ul>

<sup>2</sup> The number of Linked Parties may vary between countries.

<sup>3</sup> A party is linked to the Accounting Point at a given time, this implies that for example the old supplier should not receive updates of Accounting Point characteristics anymore.

	<ul style="list-style-type: none"> <li>• Metered Data Aggregator,</li> <li>• Metered Data Responsible,</li> <li>• Reconciliation Responsible,</li> <li>• Shipper,</li> </ul> <p>Consented Parties, the Meter Administrator and the Flexibility Register Administrator when applicable.</p> <p>For Consented Parties, the validity of the consent is checked before the notification is sent.</p>
beginsWhen	When there have been changes to the Accounting Point characteristics
preCondition	One or more parties registered by the Metering Point Administrator for this Accounting Point are entitled to receive these Accounting Point characteristics.
endsWhen	When the Linked Parties, the Consented Parties, the Meter Administrator and the Flexibility Register Administrator have received the notification.
postCondition	The characteristics of this Accounting Point are aligned between the Metering Point administration and the Linked Parties the Consented Parties and the Meter Administrator.
exceptions	None.
actions	See 2.1.3.5.2

2.1.3.5.2 Business process

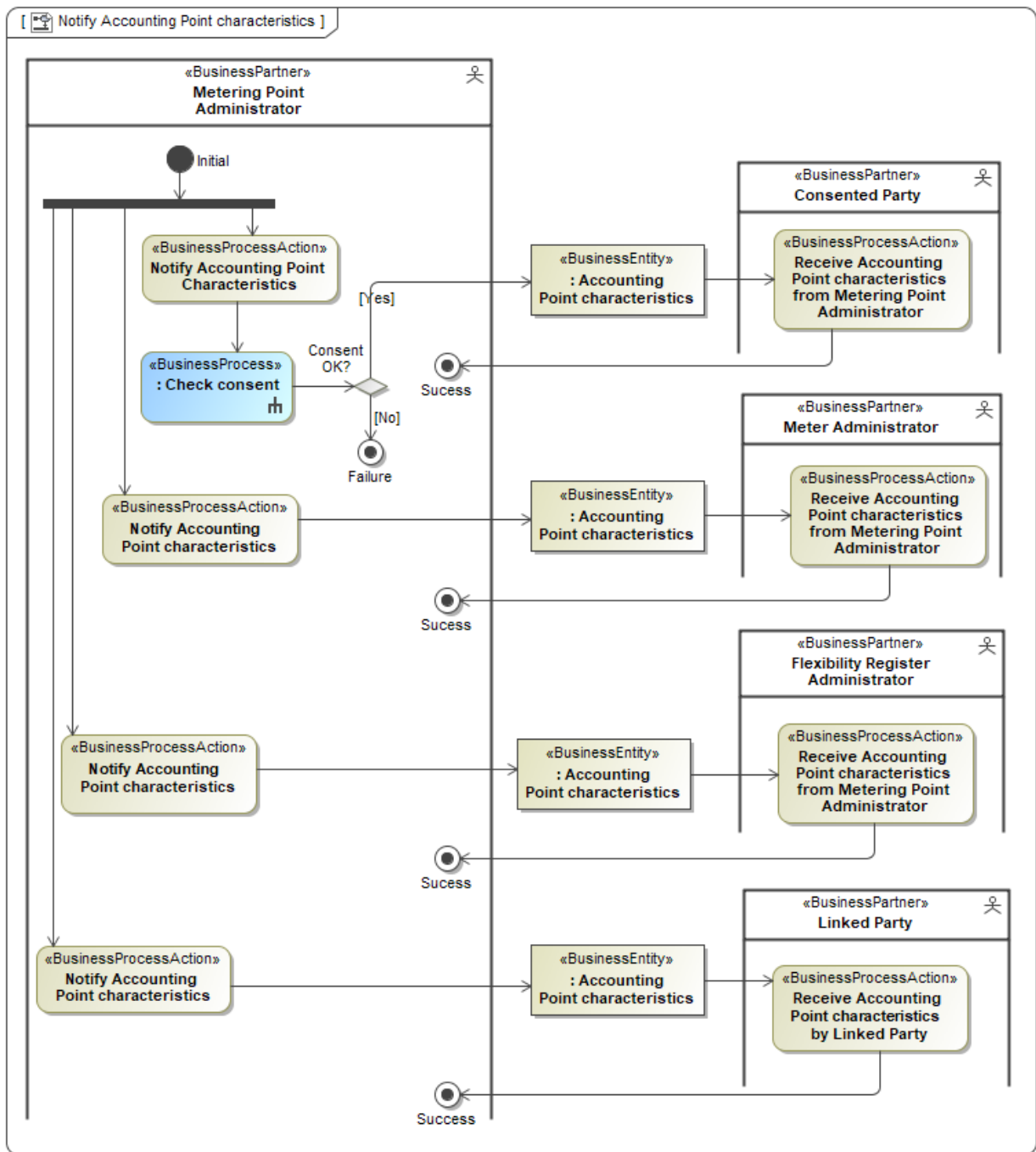

Figure 11 Business Process Notify Accounting Point characteristics

### 2.1.3.6 Request update Accounting Point characteristics

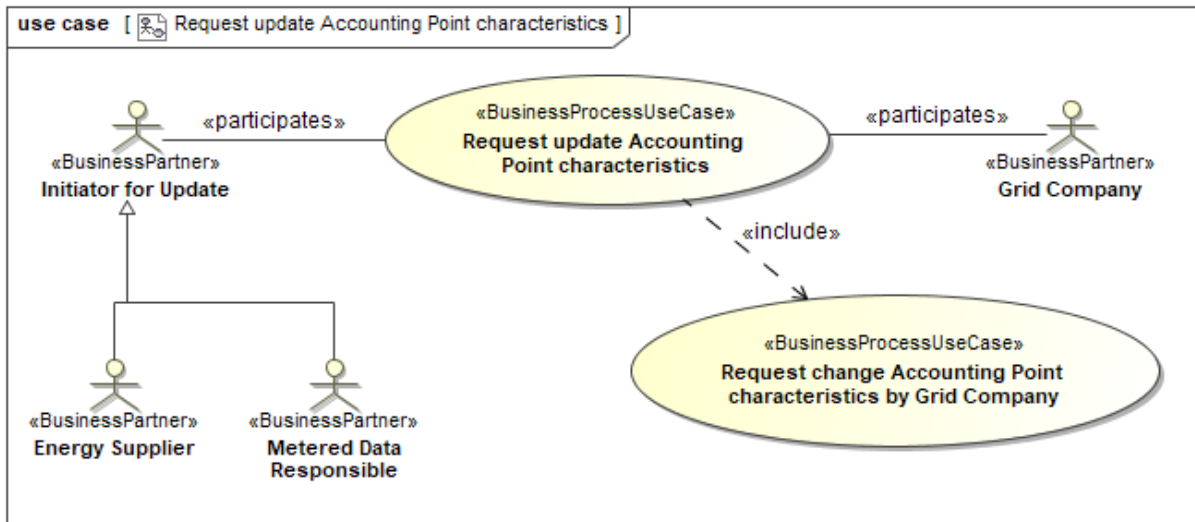

Figure 12 Request update Accounting Point characteristics

#### 2.1.3.6.1 Description

UseCase description: Request update Accounting Point characteristics													
definition	<p>In this process an Initiator for Update, i.e. the Metered Data Responsible or the Energy Supplier, requests the Grid Company for an update of one or more of the characteristics of the Accounting Point the Initiator for Update is entitled to update.</p> <p>When accepted, the Grid Company will request the Metering Point Administrator to change the Accounting Point characteristics.</p>												
beginsWhen	When the Initiator for Update needs to update Accounting Point characteristics.												
preCondition	<p>The Initiator for Update is linked to the Accounting Point.</p> <p>The following Linked Parties can request an update of the Accounting Point characteristics mentioned below at the Grid Company who is content responsible:</p> <table border="1" style="margin-left: 40px;"> <thead> <tr> <th>Accounting Point characteristics</th> <th>Initiator for Update</th> </tr> </thead> <tbody> <tr> <td>Accounting Point Address</td> <td> <ul style="list-style-type: none"> <li>• Metered Data Responsible</li> <li>• Energy Supplier</li> </ul> </td> </tr> <tr> <td>Geographical Coordinate</td> <td> <ul style="list-style-type: none"> <li>• Metered Data Responsible</li> <li>• Energy Supplier</li> </ul> </td> </tr> <tr> <td>Metering Method</td> <td> <ul style="list-style-type: none"> <li>• Energy Supplier</li> </ul> </td> </tr> <tr> <td>Meter Reading Periodicity</td> <td> <ul style="list-style-type: none"> <li>• Energy Supplier</li> </ul> </td> </tr> <tr> <td>Connection Status</td> <td> <ul style="list-style-type: none"> <li>• Energy Supplier</li> </ul> </td> </tr> </tbody> </table>	Accounting Point characteristics	Initiator for Update	Accounting Point Address	<ul style="list-style-type: none"> <li>• Metered Data Responsible</li> <li>• Energy Supplier</li> </ul>	Geographical Coordinate	<ul style="list-style-type: none"> <li>• Metered Data Responsible</li> <li>• Energy Supplier</li> </ul>	Metering Method	<ul style="list-style-type: none"> <li>• Energy Supplier</li> </ul>	Meter Reading Periodicity	<ul style="list-style-type: none"> <li>• Energy Supplier</li> </ul>	Connection Status	<ul style="list-style-type: none"> <li>• Energy Supplier</li> </ul>
Accounting Point characteristics	Initiator for Update												
Accounting Point Address	<ul style="list-style-type: none"> <li>• Metered Data Responsible</li> <li>• Energy Supplier</li> </ul>												
Geographical Coordinate	<ul style="list-style-type: none"> <li>• Metered Data Responsible</li> <li>• Energy Supplier</li> </ul>												
Metering Method	<ul style="list-style-type: none"> <li>• Energy Supplier</li> </ul>												
Meter Reading Periodicity	<ul style="list-style-type: none"> <li>• Energy Supplier</li> </ul>												
Connection Status	<ul style="list-style-type: none"> <li>• Energy Supplier</li> </ul>												

endsWhen	When the Request Update of Accounting Point characteristics has been confirmed by the Grid Company.
postCondition	The requested change of Accounting Point characteristics has been accepted by the Grid Company.
exceptions	The request for update of Accounting Point characteristics is rejected by the Grid Company.
actions	See 2.1.3.6.2

2.1.3.6.2 Business process

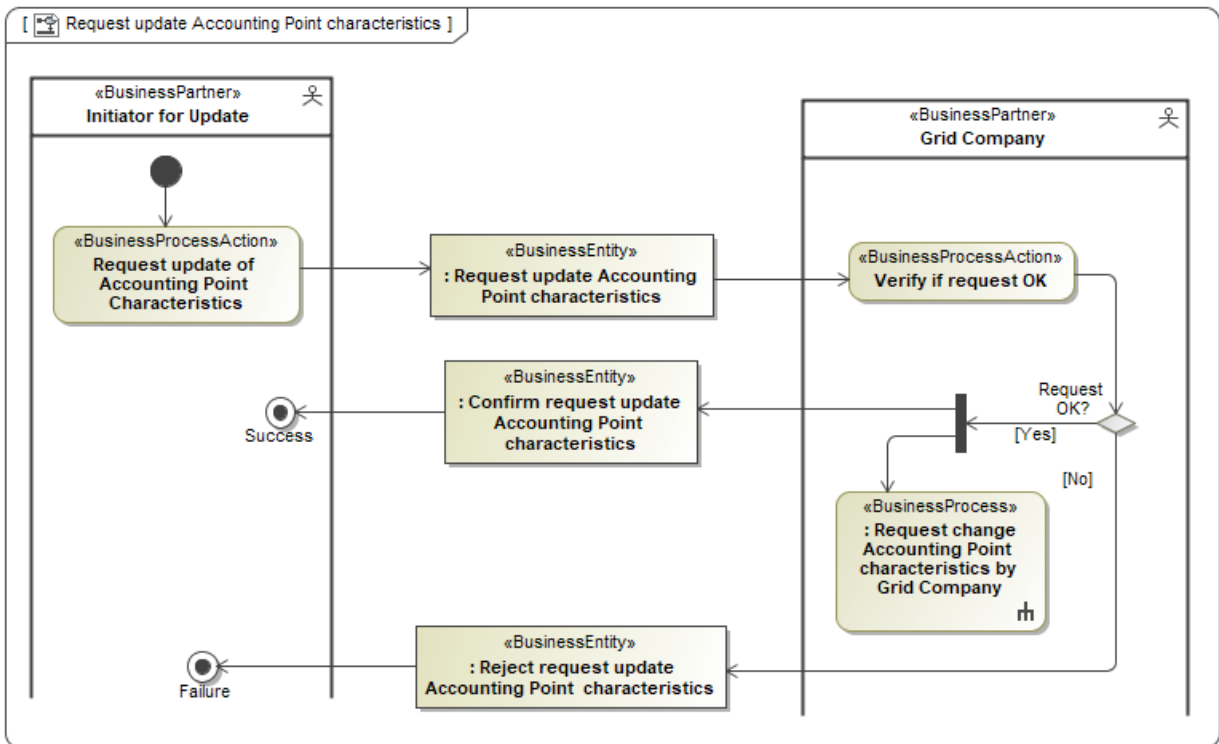

Figure 13 Business Process: Request update Accounting Point characteristics

### 2.1.3.6.3 Sequence diagram: Request Update and Change Accounting Point characteristics

The sequence diagram shown below is added for clarification:

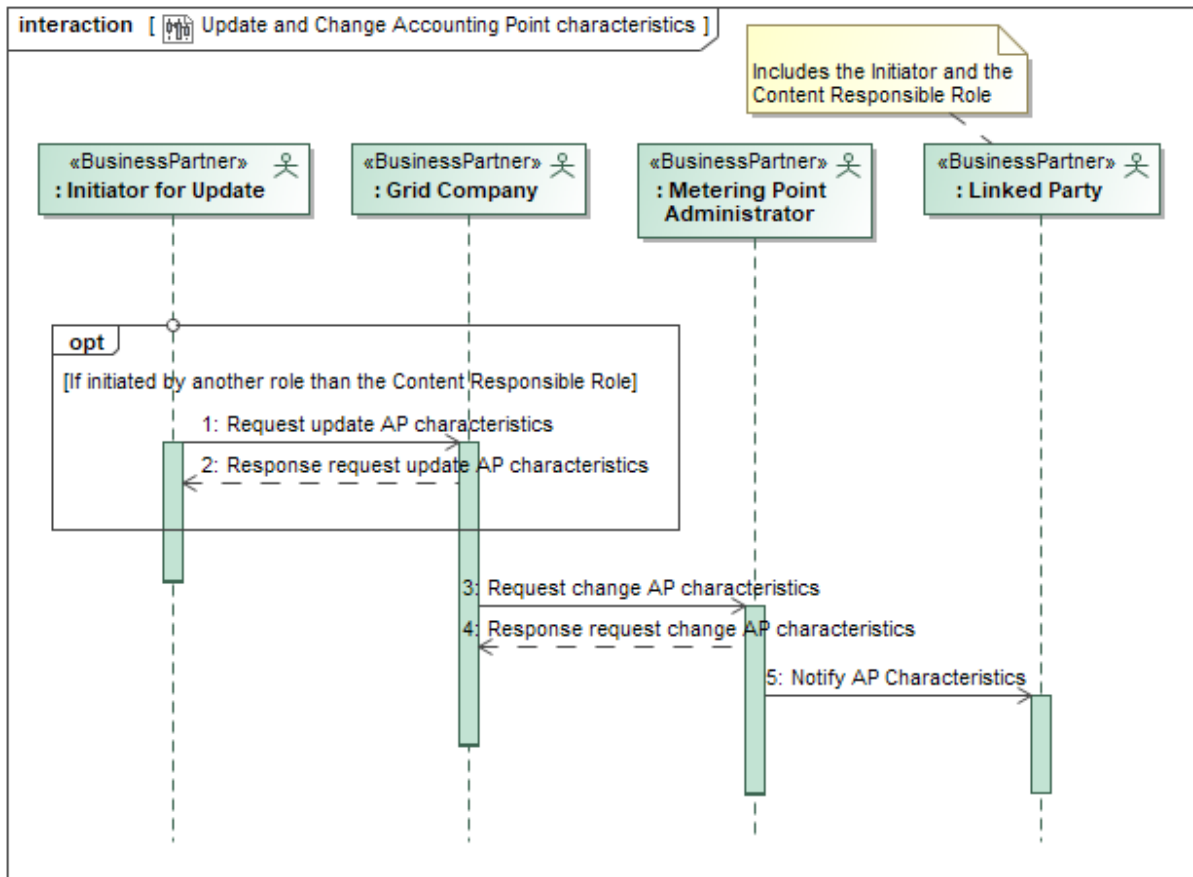

Figure 1 Sequence diagram: Request Update and Change Accounting Point characteristics

### 2.1.3.7 Determine Meter Read

Sometimes there is, based on national rules, a need for a meter read with the change of an attribute of the Accounting Point characteristics. The Process Area *Determine Meter Read* is documented in the ebIX® model Measure [7].



### 3 Business Partner View

#### 3.1 Business partners related to alignment of Accounting Point characteristics

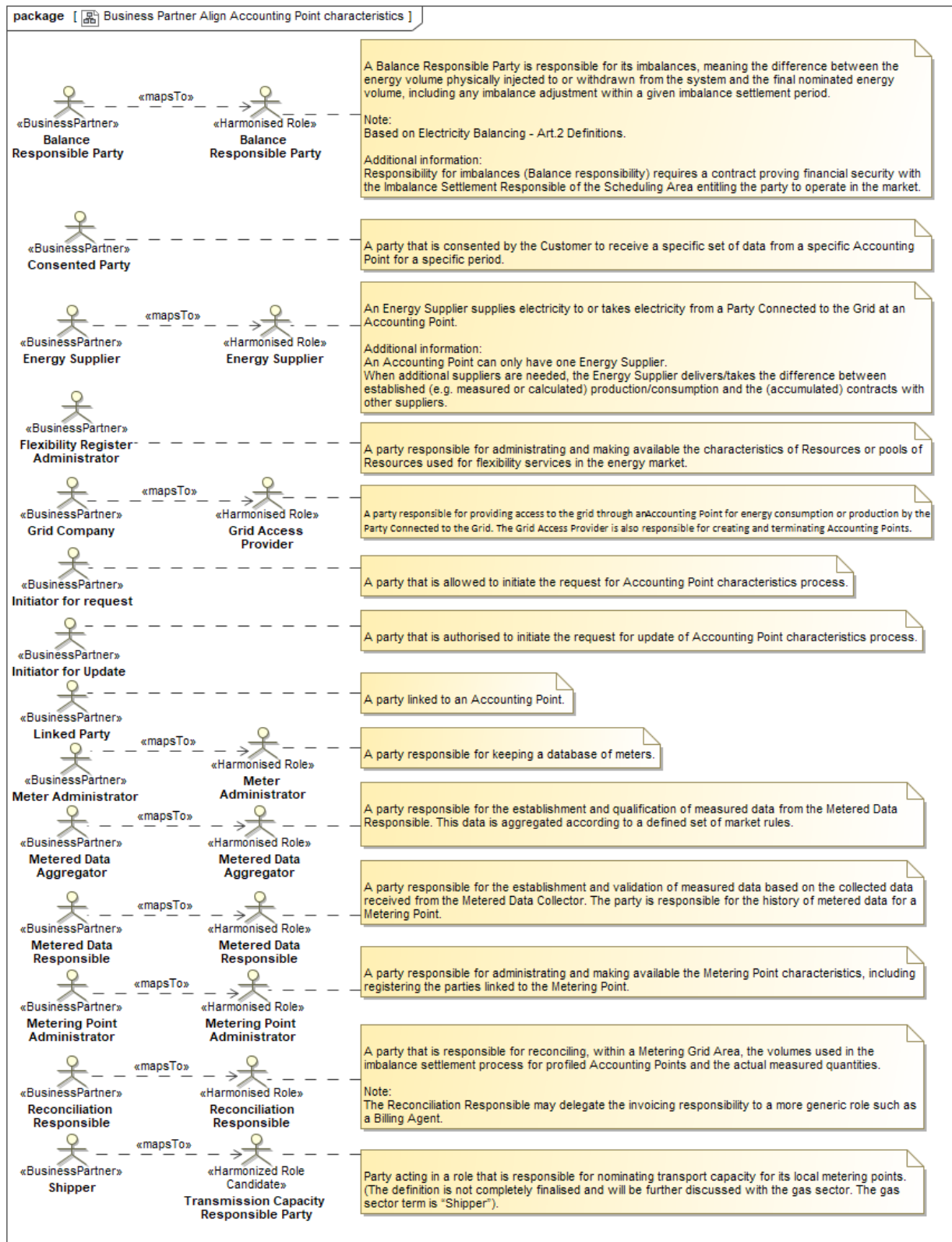

Figure 14 Business partners related to alignment of Accounting Point characteristics

## 4 Business Entity View

A general introduction to the Business Entity View can be found in the Introduction to ebIX® Business Requirements and Business Information Models ([www.ebix.org](http://www.ebix.org)) [4].

### 4.1 Accounting Point characteristics (Class Diagram)

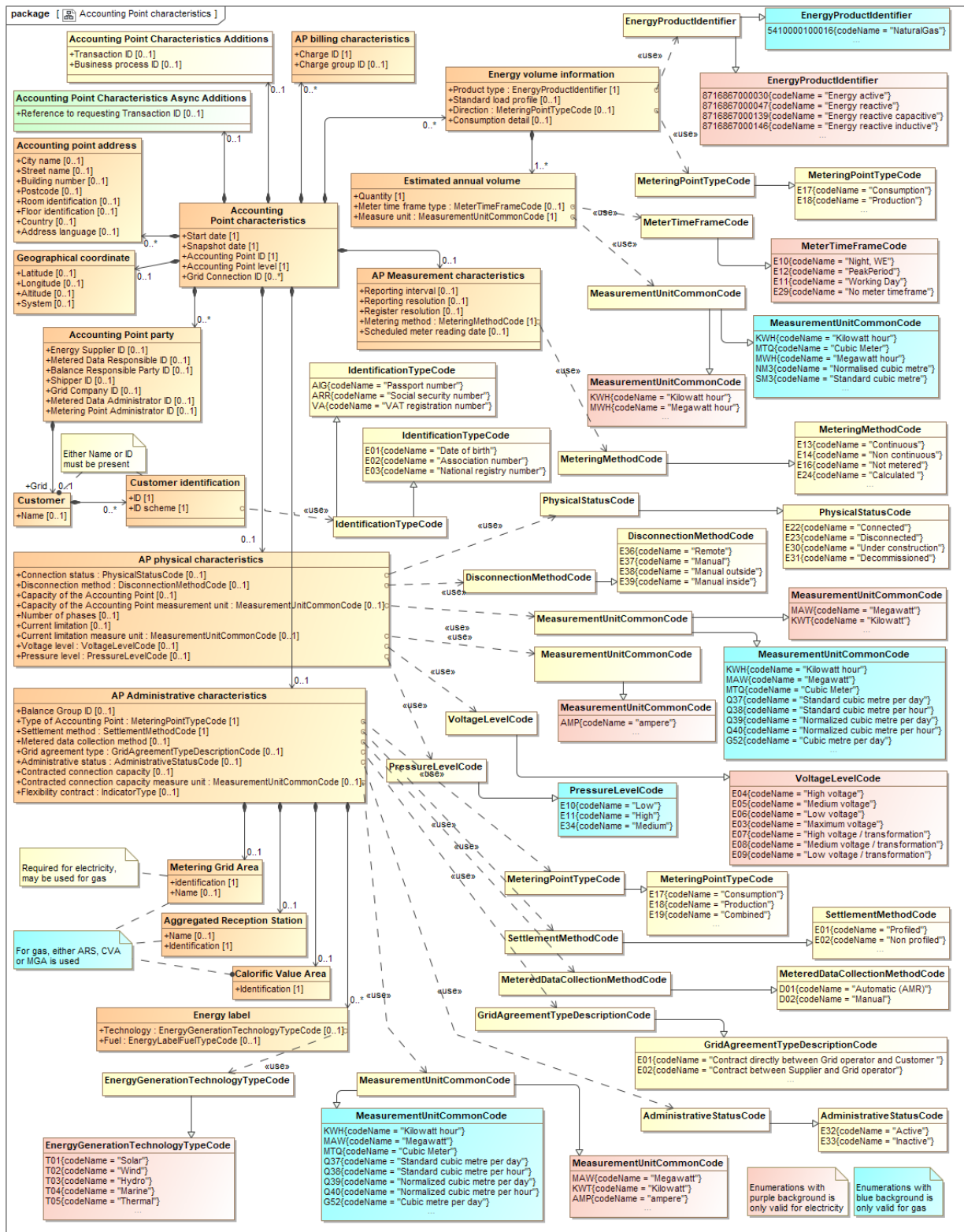

Figure 15 Accounting Point characteristics<sup>4</sup>

<sup>4</sup> The Fuel Type code list is too long to show in the class diagram, the code list can be found at [www.ebix.org](http://www.ebix.org).

#### 4.1.1 Element definitions: Accounting Point characteristics

Class/attribute	Sector <sup>5</sup>	Description
<b>«Business entity»</b> Accounting Point characteristics		The information set to be sent to a Linked Party to the Accounting Point: <ul style="list-style-type: none"> <li>• Balance Responsible Party</li> <li>• Energy Supplier</li> <li>• Grid Company</li> <li>• Metered Data Aggregator</li> <li>• Metered Data Responsible</li> <li>• Reconciliation Responsible</li> <li>• Shipper</li> </ul> a Consented Party, the Meter Administrator or the Flexibility Register Administrator to the Accounting Point from the Metering Point Administrator when Notifying responding to a request for Accounting Point characteristics for a specified Accounting Point.
Start date		The date when the content of this business document becomes or became valid.
Snapshot date		The date and time when the set of information was extracted from the Metering Point administration.
Accounting Point ID		The unique identification of the Accounting Point.
Accounting Point level		The hierarchical position of this Accounting Point in relation to the linked Accounting Point, i.e. main Accounting Point or sub–Accounting Point.
Grid Connection ID		The unique identification of the connection from this Accounting Point to the grid.
Accounting Point address		The address of the Accounting Point.  May be repeated if more than one language is used nationally.
City name		The name, expressed as text, of the city, town or village of this address.
Street name		The name, expressed as text, of this street or thoroughfare of this address.
Building number		The number, expressed as text, of the building or house on this street at this address. <sup>6</sup>
Postcode		The code specifying the postcode of this address.
Room identification		The identification, expressed as text, of the room, suite, office or apartment as part of this address.

<sup>5</sup> It is assumed that Accounting Points are uniquely dedicated to either electricity or to gas.

<sup>6</sup> The Building Number may include a “Building Number Extension”, such as one or more character making the address unique.

Floor identification		The identification by name or number, expressed as text, of the floor in the building as part of this address.
Country		The unique identifier of the country for this address (Reference ISO 3166 and UN/ECE Rec 3).
Address language		The language in which the address is specified, using ISO 639-1 two-digit language code
Geographical coordinate		The set of geographical coordinates of this Accounting Point.
Latitude		The measure of the latitude as an angular distance north or south from the Equator meridian to the meridian of this Accounting Point for this geographical coordinate. (Reference ISO 6709).
Longitude		The measure of the longitude as an angular distance east or west from the Greenwich meridian to the meridian of this Accounting Point (Reference ISO 6709).
Altitude <sup>7</sup>	Gas	The measure of the altitude that reflects the vertical elevation of this Accounting Point above a surface for this geographical coordinate (Reference ISO 6709).
System		The unique identifier of the reference system used for measuring this geographical coordinate.
Accounting Point party		The party that has a relevant responsibility for this Accounting Point.
Energy Supplier ID		The unique identification of the Energy Supplier responsible for energy supply for this Accounting Point.
Metered Data Responsible ID		The unique identification of the Metered Data Responsible, responsible for the metering of this Accounting Point.
Balance Responsible Party ID		The unique identification of the Balance Responsible Party responsible for balancing the energy for this Accounting Point.
Shipper ID		The unique identification of the Shipper responsible for capacity management of the energy for this Accounting Point.
Grid Company ID		The unique identification of the Grid Company responsible for technical maintenance and operation of the connection of this Accounting Point.
Metered Data Administrator ID		The unique identification of the Metered Data Administrator, responsible for the administration of the measured data for this Accounting Point.
Metering Point Administrator ID		The unique identification of the Metering Point Administrator, responsible for the administration of this Accounting Point.
Grid Customer		The Customer that has the contract for access and transport of energy for this Accounting Point.

<sup>7</sup> The altitude of the meter may be used in the gas sector for correction purposes.

Name		The name of the Grid Customer
Customer identification		The Identification of a Customer
ID		The unique identification of the Customer at the Accounting Point.
ID scheme		The Identification scheme used for the identification of the Customer in question
AP physical characteristics		The relevant physical characteristics of this Accounting Point.
Connection status		A code specifying if the installation of the Accounting Point is physically connected to the grid and energy flow is possible.
Disconnection method		The Disconnection Method is an indication of how the Accounting Point is physically connected or disconnected.
Capacity of the Accounting Point		<p>Capacity of an Accounting Point is the maximum physical capacity of the Accounting Point.</p> <p>For electricity, the maximum capacity for the Accounting Point is given in kW or MW or calculated from the nominal voltage level, number of phases and current limitations. The “Capacity of an Accounting Point” can be sent as the calculated capacity in kW or MW and/or as a combination of:</p> <ul style="list-style-type: none"> <li>• Number of phases</li> <li>• Fuse size</li> <li>• Voltage level</li> </ul>
Capacity of the Accounting Point measure unit		<p>The measure unit used for the capacity of the Accounting Point.</p> <p>For gas the maximum capacity for the Accounting Point is given in m<sup>3</sup>/hour, usually determined by the physical constraints of the (nozzles in the) Meter.</p>
Number of phases	Elec	The number of phases in the Accounting Point, either 1 or 3.
Current limitation	Elec	The current limitation, i.e. maximum current or fuse size, for the Accounting Point in Ampere
Current limitation measure unit	Elec	The measure unit used for the current limitation, i.e. Ampere
Voltage level	Elec	A code specifying the voltage level of the grid to which the installation of the Accounting Point is connected.
Pressure level	Gas	A code specifying the gas pressure in the grid to which the installation of the Accounting Point is connected.
AP Administrative characteristics		The relevant administrative characteristics of this Accounting Point.
Balance Group ID		The unique identification of the Balance Group to which this Accounting Point belongs.

Type of Accounting Point		A code specifying the direction of the active energy flow in this Accounting Point, such as consumption, production or combined.
Settlement method		A code specifying how the energy volumes are treated for settlement for this Accounting Point, such as profiled or non-profiled. <sup>8</sup>
Metered data collection method		A code specifying how a Metered Data Collector collects data from the Meter for this Accounting Point, such as Automatic or Manually.
Grid agreement type		Specification of type of grid contract, such as if the contract is directly between the Grid Company and the Grid Customer, or through the Energy Supplier.
Administrative status		A code specifying whether (or not) the Accounting Point is part of the imbalance settlement.
Contracted connection capacity		Quantitative information about the capacity of the connection that is contracted for the Accounting Point.
Contracted connection capacity measure unit		The unit of measure used for the Contracted Connection Capacity.
Flexibility contract		Indicates if there is a contract at the Accounting Point for flexibility services from this Accounting Point. The element is Boolean and used for both gas and electricity.
Energy label		A class indicating the origin of the energy produced at this Accounting Point
Technology		An indication of the technology of the energy production, or part of the energy production, which is potentially fed into the grid at this Accounting Point.
Fuel		An indication of the fuel used for the energy production, or part of the energy production, which is potentially fed into the grid at this Accounting Point.
«Business entity» Metering Grid Area	Elec	The Metering Grid Area the Accounting Point belongs to. The Metering Grid Area is a physical area where consumption, production and exchange of (electrical) energy can be metered <sup>9</sup> .
Identification		The unique identification of the Metering Grid Area to which this Accounting Point belongs.
MGA name		The name, in clear text, of the Metering Grid Area.

<sup>8</sup> A profiled Accounting Point is always a part of the reconciliation process as opposed to non-profiled.

<sup>9</sup> The definition is simplified version of the definition in the ebIX®, EFET and ENTSO-E Harmonised Role model [3].

«Business entity» Aggregated Reception Station	Gas	An administrative entity that represents one or more Reception Stations for gas where the gas quality is regarded to be the same. <b>Dependency:</b> Use either Aggregated Reception Station or Calorific Value Area.
Identification		The unique identification of the Aggregated Reception Station to which this Accounting Point belongs.
Name		The name, in clear text, of the Aggregated Reception Station.
«Business entity» Calorific Value Area	Gas	A set of Accounting Points where the calorific value for the quality of supplied gas is assumed to be the same.
Identification		The unique identification of the Calorific Value Area to which this Accounting Point belongs.
AP billing characteristics		The relevant billing characteristics of this Accounting Point.
Charge ID		The unique identification of the Charge applicable for this Accounting Point.
Charge group ID		The unique identification of the Charge group applicable for this Accounting Point. A Charge group is a set of Charges valid for a set of Accounting Point with similar characteristics.
Energy volume information		Characteristics of the energy volume for this Accounting Point, among others for reconciliation purposes.
Product type		A code specifying the energy product for the estimated annual volume.
Standard load profile		The standard load profile for this Accounting Point.
Direction		A code specifying the direction of the energy flow to an/or from this Accounting Point, such as consumption or production or both.
Consumption detail		An indication of the kind of consumption at this Accounting Point, such as production unit's own consumption, pumped or disconnectable consumption.
Estimated annual volume		The energy volume used for profiled nomination and allocation for this Accounting Point.
Quantity		The estimated annual volume for the specified time frame.
Meter time frame type	Elec	A code specifying the tariff time frame for this estimated annual volume.
Measure unit		The unit of measure used for the Estimated Annual Volume.



AP measurement characteristics		Characteristics of the measurement reporting from this Accounting Point.
Reporting interval		<p>The time between publications of meter readings from the Metered Data Administrator, expressed in compliance with ISO 8601 in the following format:</p> <p style="text-align: center;">PnYnMnDTnHnMnS.</p> <p>For example <b>PT1D</b> for daily publications.</p>
Reporting resolution		<p>The length of each observation that is reported to the market from the Metered Data Administrator, expressed in compliance with ISO 8601 in the following format:</p> <p style="text-align: center;">PnYnMnDTnHnMnS.</p> <p>For example <b>PT1H</b> for hourly resolution.</p>
Register resolution		<p>The length of each observation that is registered in the Register in the Meter, expressed in compliance with ISO 8601 in the following format:</p> <p style="text-align: center;">PnYnMnDTnHnMnS.</p> <p>For example <b>PT15M</b> for 15 minutes resolution.</p>
Metering method		A code specifying how the energy volumes are established for this Accounting Point, such as continuous- non-continuous- or not-metered.
Scheduled meter reading date		The indication of when the regular meter reading is scheduled.
Accounting Point characteristics Additions		Information related to the exchange of the Request Accounting Point characteristics, to be agreed on a national level.
Transaction ID		The unique identification of this set of information, given by the Initiator.
Business process ID		The unique identification, given by the Metering Point Administrator, of this Request Accounting Point characteristics process that this exchange is part of.
Accounting Point characteristics Async Additions		Information related to the exchange of the request for Accounting Point characteristics, needed when using asynchronous communication.
Reference to requesting Transaction ID		<p>A reference to the requesting business document, used in the responding business document in a business transaction.</p> <p>Only used when responding to a request.</p>

## 4.2 Request Accounting Point characteristics (Class Diagram)

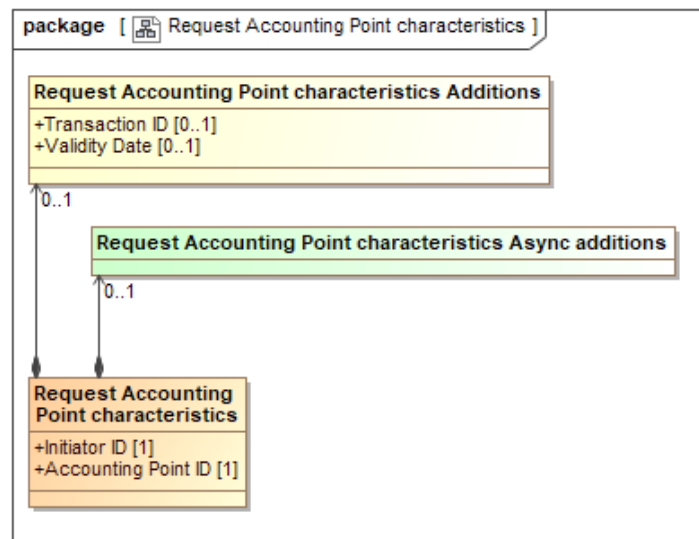

Figure 16 Request Accounting Point characteristics

### 4.2.1 Element definitions: Request Accounting Point characteristics

Class/attribute	Sector <sup>10</sup>	Description
«Business entity» Request Accounting Point characteristics		<p>The information set to be sent by an Initiator or Request, i.e. a Linked Party to the Accounting Point:</p> <ul style="list-style-type: none"> <li>• Balance Responsible Party</li> <li>• Energy Supplier</li> <li>• Grid Company</li> <li>• Metered Data Aggregator</li> <li>• Metered Data Responsible</li> <li>• Reconciliation Responsible</li> <li>• Shipper</li> </ul> <p>a Consented Party, the Meter Administrator or the Flexibility Register Administrator to the Accounting Point to the Metering Point Administrator when requesting Accounting Point characteristics</p>
Initiator ID		The unique identification of the Linked Party <sup>11</sup> or the Consented Party that requests Accounting Point characteristics for this Accounting Point.
Accounting Point ID		The unique identification of the Accounting Point.

<sup>10</sup> It is assumed that Accounting Points are uniquely dedicated to either electricity or to gas.

<sup>11</sup> The Linked Parties are listed under 2.1.3.5, Business Domain View: Notify Accounting Point characteristics (Business Process UseCase)

Request Accounting Point characteristics Additions		Additional information, related to Request Accounting Point characteristics, to be agreed on a national level
Transaction ID		The unique identification of this set of information, given by the Initiator.
Validity Date <sup>12</sup>		The date for when the requested Accounting Point characteristics shall be valid.
Request Accounting Point characteristics Async Additions		Additional information, related to Requesting Accounting Point characteristics, needed when using asynchronous communication, however not used in this request.

---

<sup>12</sup> The validity date cannot be older than the start of the responsibility of the requestor for this Accounting Point.

### 4.3 Reject request Accounting Point characteristics (Class Diagram)

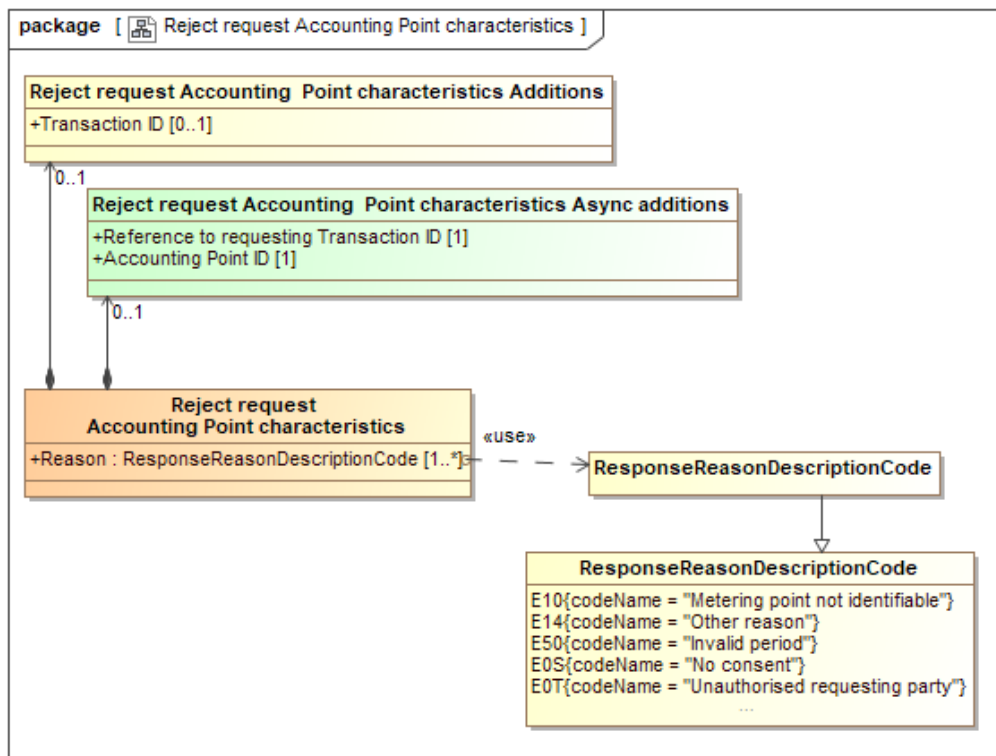

Figure 17 Reject request Accounting Point characteristics

#### 4.3.1 Element definitions: Reject request Accounting Point characteristics

Class/attribute	Sector <sup>13</sup>	Description
<p>«Business entity»</p> <p>Reject request Accounting Point characteristics</p>		<p>The information set sent from the Metering Point Administrator to the Initiator or Request, i.e. a Linked Party to the Accounting Point:</p> <ul style="list-style-type: none"> <li>• Balance Responsible Party</li> <li>• Energy Supplier</li> <li>• Grid Company</li> <li>• Metered Data Aggregator</li> <li>• Metered Data Responsible</li> <li>• Reconciliation Responsible</li> <li>• Shipper</li> </ul> <p>a Consented Party, the Meter Administrator or the Flexibility Register Administrator to the Accounting Point when rejecting a request for Accounting Point characteristics.</p>
Reason		A code specifying (one of) the reason(s) for the rejection of the Request Accounting Point characteristics.

<sup>13</sup> It is assumed that Accounting Points are uniquely dedicated to either electricity or to gas.

Reject request Accounting Point Characteristics Additions		Additional information related to rejecting the Request Accounting Point characteristics, to be agreed on a national level.
Transaction ID		The unique identification of this set of information given by the Metering Point Administrator.
Reject request Accounting Point characteristics Async Additions		Additional information, related to the rejection of the Request Accounting Point characteristics, needed when using asynchronous communication.
Reference to requesting Transaction ID		The Transaction ID from the request, where this is the response for, given by the Initiator.
Accounting Point ID		The unique identification of the Accounting Point the rejected request was aimed for.

### 4.4 Request change Accounting Point characteristics by Grid Company (Class Diagram)

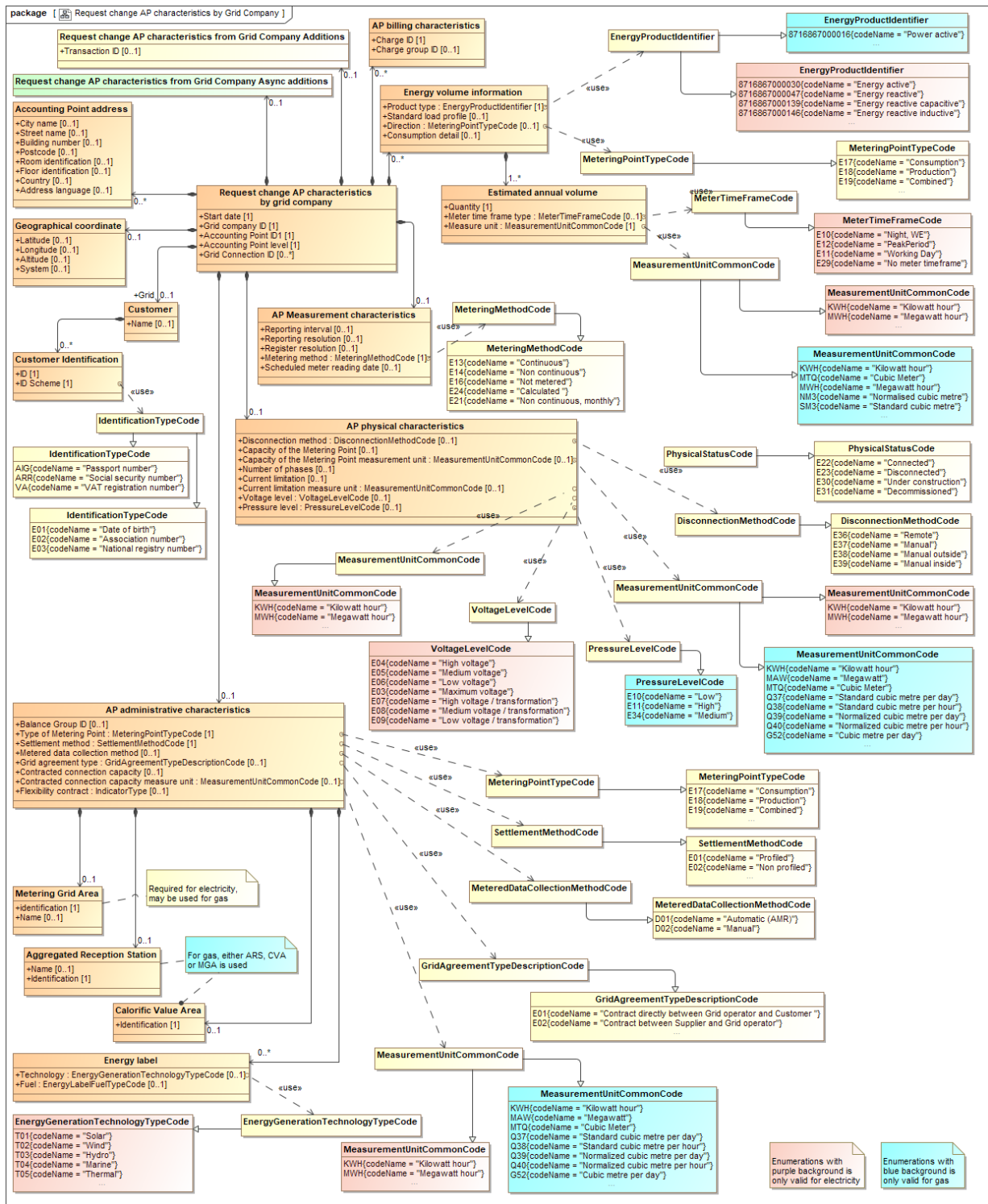

Figure 18 Request change Accounting Point characteristics by Grid Company<sup>14</sup>

<sup>14</sup> The Fuel Type code list is too long to show in the class diagram, the full code list can be found at [www.ebix.org](http://www.ebix.org).

#### 4.4.1 Element definitions: Request change Accounting Point characteristics by Grid Company

Class/attribute	Sector 15	Description
«Business entity» Request change Accounting Point characteristics by grid company		The information set to be sent from a Grid Company (Content Responsible Role) to the Metering Point Administrator when requesting Change Accounting Point characteristics.
Start date		The date when the updated characteristics of this business document become or became valid.
Grid company ID		The unique identification of the Grid Company requesting change of characteristics for this Accounting Point.
Accounting Point ID		The unique identification of the Accounting Point the updated characteristics belong to.
Accounting Point level		The hierarchical position of this Accounting Point in relation to the linked Accounting Point, i.e. main Accounting Point or sub–Accounting Point.
Grid Connection ID		The unique identification of the connection from this Accounting Point to the grid.
Accounting Point address		The address of the Accounting Point.  May be repeated if more than one language is used nationally.
City name		The name, expressed as text, of the city, town or village of this address.
Street name		The name, expressed as text, of this street or thoroughfare of this address.
Building number		The number, expressed as text, of the building or house on this street at this address <sup>16</sup> .
Postcode		The code specifying the postcode of this address.
Room identification		The identification, expressed as text, of the room, suite, office or apartment as part of this address.
Floor identification		The identification by name or number, expressed as text, of the floor in the building as part of this address.
Country		The unique identifier of the country for this address (Reference ISO 3166 and UN/ECE Rec 3).
Address language		The language in which the address is specified.

<sup>15</sup> It is assumed that Accounting Points are uniquely dedicated to either electricity or to gas.

<sup>16</sup> The Building Number may include a “Building Number Extension”, such as one or more character making the address unique.

Class/attribute	Sector 15	Description
Geographical coordinate		The set of geographical coordinates of this Accounting Point.
Latitude		The measure of the latitude as an angular distance north or south from the Equator meridian to the meridian of this Accounting Point for this geographical coordinate. (Reference ISO 6709).
Longitude		The measure of the longitude as an angular distance east or west from the Greenwich meridian to the meridian of this Accounting Point (Reference ISO 6709).
Altitude <sup>17</sup>	Gas	The measure of the altitude that reflects the vertical elevation of this Accounting Point above a surface for this geographical coordinate (Reference ISO 6709).
System		The unique identifier of the reference system used for measuring this geographical coordinate.
Grid Customer		The Customer that has the contract for access and transport of energy for this Accounting Point.
Name		The name of the Grid Customer
Customer identification		The Identification of a Customer
ID		The unique identification of the Customer at the Accounting Point.
ID Scheme		The Identification scheme used for the identification of the Customer in question
AP administrative characteristics		The relevant administrative characteristics of this Accounting Point.
Balance Group ID		The unique identification of the Balance Group to which this Accounting Point belongs.
Type of Accounting Point		A code specifying the direction of the active energy flow in this Accounting Point, such as consumption, production or combined.
Metering method		A code specifying how the energy volumes are established for this Accounting Point, such as continuous- non-continuous- or not-metered.
Settlement method		A code specifying how the energy volumes are treated for settlement for this Accounting Point, such as profiled or non-profiled <sup>18</sup> .
Scheduled meter reading date		The indication of when the regular meter reading is scheduled.

<sup>17</sup> The altitude of the meter may be used in the gas sector for correction purposes.

<sup>18</sup> A profiled Accounting Point is always a part of the reconciliation process as opposed to non-profiled.



Class/attribute	Sector 15	Description
Meter reading periodicity		The length of time between the meter readings.
Metered data collection method		A code specifying how a Metered Data Collector collects data from the Meter for this Accounting Point, such as Automatic or Manually.
Grid agreement type		Specification of type of grid contract, such as if the contract is directly between the Grid Company and the Grid Customer, or through the Energy Supplier.
Contracted connection capacity		Quantitative information about the capacity of the connection that is contracted for the Accounting Point.
Contracted connection capacity measure unit		The unit of measure used for the Contracted Connection Capacity.
Flexibility contract		Indicates if there is a contract at the Accounting Point for flexibility services from this Accounting Point. The element is Boolean and used for both gas and electricity.
«Business entity» Metering Grid Area	Elec	The Metering Grid Area the Accounting Point belongs to. The Metering Grid Area is a physical area where consumption, production and exchange of (electrical) energy can be metered <sup>19</sup> .
Identification		The unique identification of the Metering Grid Area to which this Accounting Point belongs.
Name		The name, in clear text, of the Metering Grid Area.
«Business entity» Aggregated Reception Station	Gas	An administrative entity that represents one or more Reception Stations for gas where the gas quality is regarded to be the same. <b>Dependency:</b> Use either Aggregated Reception Station or Calorific Value Area.
Identification		The unique identification of the Aggregated Reception Station to which this Accounting Point belongs.
Name		The name, in clear text, of the Aggregated Reception Station.
«Business entity» Calorific Value Area	Gas	A set of Accounting Points where the calorific value for the quality of supplied gas is assumed to be the same.
Identification		The unique identification of the Calorific Value Area to which this Accounting Point belongs.
Energy Label		A class indicating the origin of the energy produced at this Accounting Point

<sup>19</sup> The definition is simplified version of the definition in the ebIX®, EFET and ENTSO-E Harmonised Role model [3].

Class/attribute	Sector 15	Description
Technology		An indication of the technology of the energy production, or part of the energy production, which is potentially fed into the grid at this Accounting Point.
Fuel		An indication of the source (fuel) used for the energy production, or part of the energy production, which is potentially fed into the grid at this Accounting Point.
AP physical characteristics		The relevant physical characteristics of this Accounting Point.
Disconnection method		An indication of how the Accounting Point is physically connected or disconnected.
Capacity of the Accounting Point		<p>Capacity of the Accounting Point, being the maximum physical capacity of (the connection to the installation of) the Accounting Point.</p> <p>For electricity, the maximum capacity for the Accounting Point is given in kW or MW or calculated from the nominal voltage level, number of phases and current limitations. The “Capacity of an Accounting Point” can be sent as the calculated capacity in kW or MW and/or as a combination of:</p> <ul style="list-style-type: none"> <li>• Number of phases</li> <li>• Fuse size</li> <li>• Voltage level</li> </ul>
Capacity of the Accounting Point M measure unit		<p>The measure unit used for the capacity of the Accounting Point.</p> <p>For gas the maximum capacity for the Accounting Point is given in m<sup>3</sup>/hour, usually determined by the physical constraints of the (nozzles in the) Meter.</p>
Number of phases	Elec	The number of phases in the Accounting Point, either 1 or 3.
Current limitation	Elec	The current limitation, i.e. maximum current or fuse size, for the Accounting Point in Ampere
Current limitation measure unit	Elec	The measure unit used for the current limitation, i.e. Ampere
Voltage level	Elec	A code specifying the voltage level of the grid where the installation of the Accounting Point is connected.
Pressure level	Gas	A code specifying the gas pressure in the grid where the installation of the Accounting Point is connected.
AP billing characteristics		The relevant billing characteristics of this Accounting Point.
Charge ID		The unique identification of the Charge applicable for this Accounting Point.

Class/attribute	Sector 15	Description
Charge group ID		The unique identification of the Charge group applicable for this Accounting Point. A Charge group is a set of Charges valid for a set of Accounting Point with similar characteristics.
Energy volume information		Characteristics of the energy volume for this Accounting Point, among others for reconciliation purposes.
Product type		A code specifying the energy product for the estimated annual volume.
Standard load profile		The standard load profile for this Accounting Point.
Direction		A code specifying the direction of the energy in the estimated annual volume for this Accounting Point, such as consumption, production or both.
Consumption detail		An indication of the kind of consumption at this Accounting Point, such as production unit's own consumption, pumped or disconnectable consumption.
Estimated annual volume		The energy volume used for profiled nomination and allocation for this Accounting Point.
Quantity		The estimated annual volume for the specified time frame.
Meter time frame type	Elec	A code specifying the tariff time frame for this estimated annual volume.
Measure Unit		The unit of measure used for the Estimated Annual Volume.
AP measurement characteristics		Characteristics of the measurement reporting from this Accounting Point.
Reporting interval		The time between publications of meter readings from the Metered Data Administrator, expressed in compliance with ISO 8601 in the following format:  PnYnMnDTnHnMnS.  For example <b>PT1D</b> for daily publications.
Reporting resolution		The length of each observation that is reported to the market from the Metered Data Administrator, expressed in compliance with ISO 8601 in the following format:  PnYnMnDTnHnMnS.  For example <b>PT1H</b> for hourly resolution.
Register resolution		The length of each observation that is registered in the Register in the Meter, expressed in compliance with ISO 8601 in the following format:  PnYnMnDTnHnMnS.  For example <b>PT15M</b> for 15 minutes resolution.

Class/attribute	Sector 15	Description
Metering method		A code specifying how the energy volumes are established for this Accounting Point, such as continuous- non-continuous- or not-metered.
Scheduled meter reading date		The indication of when the regular meter reading is scheduled.
Request change Accounting Point characteristics by Grid Company Additions		Information related to the document exchange, to be agreed on a national level.
Transaction ID		The unique identification of this set of information, given by the Initiator.
Request change Accounting Point characteristics by Grid Company Async Additions		Information related to the document exchange, needed when using asynchronous communication.

### 4.5 Confirm request change Accounting Point characteristics by Grid Company (Class Diagram)

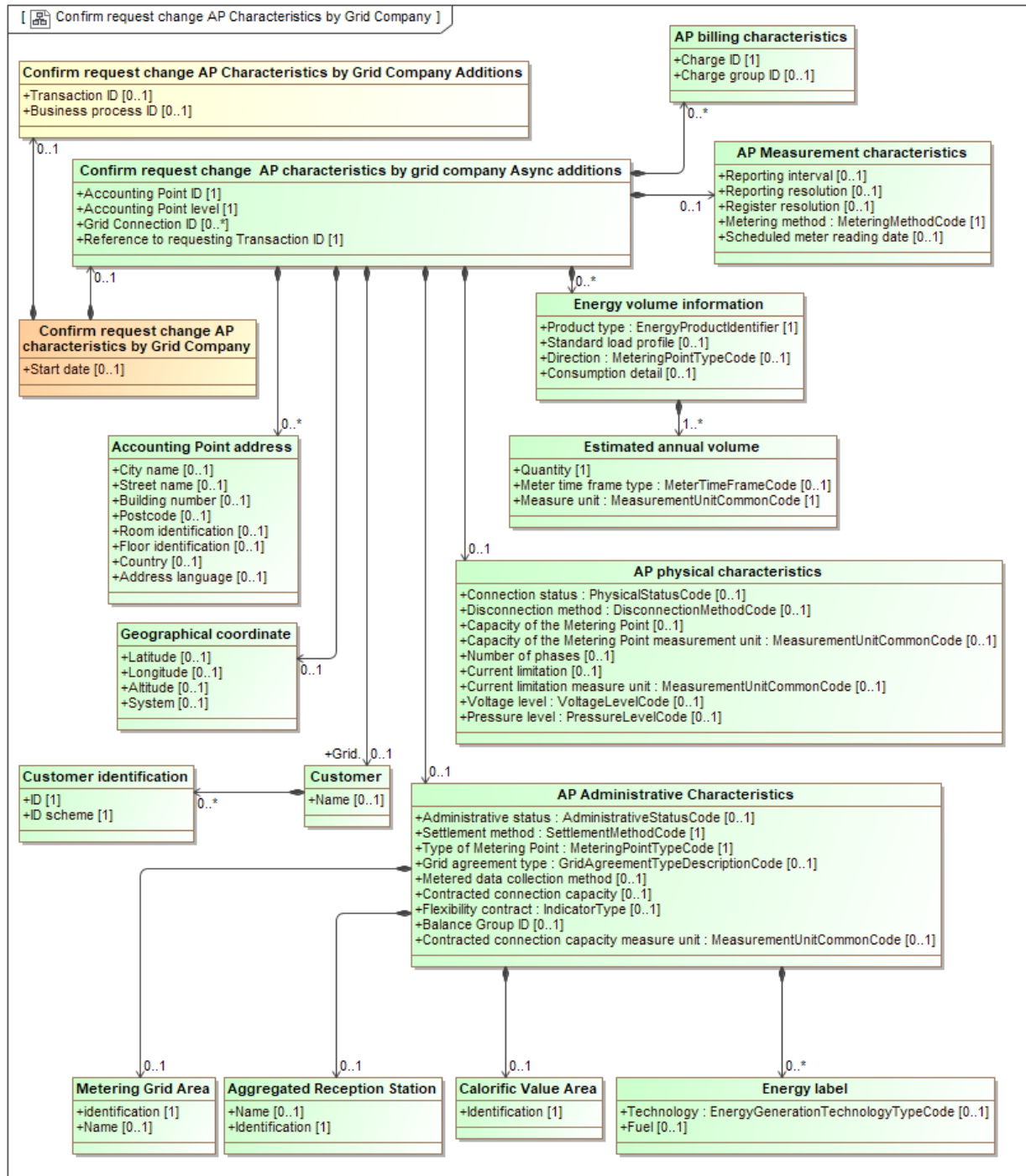

Figure 19 Confirm request change Accounting Point characteristics by Grid Company

**Note:**

- The attributes and attribute values in the confirmation shall be the same as in the corresponding request, therefore we allow us to only show the updated classes and attributes, hence skipping the coded values in the class diagram above.

#### 4.5.1 Element definitions: Confirm request change Accounting Point characteristics by Grid Company

Class/attribute	Sector <sup>20</sup>	Description
«Business entity» Confirm request change Accounting Point characteristics by Grid Company		The information set to be sent from the Metering Point Administrator to the Grid Company (Content Responsible Role) when confirming a request for Change Accounting Point characteristics.
Start date		The confirmed start date for this requested change. <b>Dependency:</b> <ul style="list-style-type: none"> <li>The usage of Start date is dependent on national rules.</li> </ul>
Confirm request change Accounting Point characteristics by Grid Company Additions		Information related to the document exchange, to be agreed on a national level.
Transaction ID		The unique identification of this set of information, given by the Initiator.
Business Process ID		The unique identification of the instance of the process that this transaction is a part of.
Confirm request change Accounting Point characteristics by Grid Company Async Additions		Information related to the document exchange, needed when using asynchronous communication.
Accounting Point ID		The unique identification of the Accounting Point the change of characteristics is confirmed for.
Accounting Point level		The hierarchical position of this Accounting Point in relation to the linked Accounting Point, i.e. main Accounting Point or sub-Accounting Point.
Grid Connection ID		The unique identification of the connection from this Accounting Point to the grid.
Reference to Requesting Transaction ID		The Transaction ID from the request.
Accounting Point address		The address of the Accounting Point. May be repeated if more than one language is used nationally.
City name		The name, expressed as text, of the city, town or village of this address.

<sup>20</sup> It is assumed that Accounting Points are uniquely dedicated to either electricity or to gas.

Class/attribute	Sector 20	Description
Street name		The name, expressed as text, of this street or thoroughfare of this address.
Building number		The number, expressed as text, of the building or house on this street at this address <sup>21</sup> .
Postcode		The code specifying the postcode of this address.
Room identification		The identification, expressed as text, of the room, suite, office or apartment as part of this address.
Floor identification		The identification by name or number, expressed as text, of the floor in the building as part of this address.
Country		The unique identifier of the country for this address (Reference ISO 3166 and UN/ECE Rec 3).
Address language		The language in which the address is specified.
Geographical coordinate		The set of geographical coordinates of this Accounting Point.
Latitude		The measure of the latitude as an angular distance north or south from the Equator meridian to the meridian of this Accounting Point for this geographical coordinate. (Reference ISO 6709).
Longitude		The measure of the longitude as an angular distance east or west from the Greenwich meridian to the meridian of this Accounting Point (Reference ISO 6709).
Altitude <sup>22</sup>	Gas	The measure of the altitude that reflects the vertical elevation of this Accounting Point above a surface for this geographical coordinate (Reference ISO 6709).
System		The unique identifier of the reference system used for measuring this geographical coordinate.
Grid Customer		The Customer that has the contract for access and transport of energy for this Accounting Point.
Name		The name of the Grid Customer
Customer identification		The Identification of a Customer
ID		The unique identification of the Customer at the Accounting Point.
ID scheme		The Identification scheme used for the identification of the Customer in question

<sup>21</sup> The Building Number may include a “Building Number Extension”, such as one or more character making the address unique.

<sup>22</sup> The altitude of the meter may be used in the gas sector for correction purposes.

Class/attribute	Sector 20	Description
AP administrative characteristics		The relevant administrative characteristics of this Accounting Point.
Balance Group ID		The unique identification of the Balance Group to which this Accounting Point belongs.
Type of Accounting Point		A code specifying the direction of the active energy flow in this Accounting Point, such as consumption, production or combined.
Metering method		A code specifying how the energy volumes are established for this Accounting Point, such as continuous- non-continuous- or not-metered.
Settlement method		A code specifying how the energy volumes are treated for settlement for this Accounting Point, such as profiled or non-profiled <sup>23</sup> .
Scheduled meter reading date		The indication of when the regular meter reading is scheduled.
Meter reading periodicity		The length of time between the meter readings.
Metered data collection method		A code specifying how a Metered Data Collector collects data from the Meter for this Accounting Point, such as Automatic or Manually.
Grid agreement type		Specification of type of grid contract, such as if the contract is directly between the Grid Company and the Grid Customer, or through the Energy Supplier.
Administrative status		A code specifying whether (or not) the Accounting Point is part of the imbalance settlement.
Contracted connection capacity		Quantitative information about the capacity of the connection that is contracted for the Accounting Point.
Contracted connection capacity measure unit		The unit of measure used for the Contracted Connection Capacity.
Flexibility contract		Indicates if there is a contract at the Accounting Point for flexibility services from this Accounting Point. The element is Boolean and used for both gas and electricity.

<sup>23</sup> A profiled Accounting Point is always a part of the reconciliation process as opposed to non-profiled.



Class/attribute	Sector 20	Description
«Business entity» Metering Grid Area	Elec	The Metering Grid Area the Accounting Point belongs to. The Metering Grid Area is a physical area where consumption, production and exchange of (electrical) energy can be metered <sup>24</sup> .
Identification		The unique identification of the Metering Grid Area to which this Accounting Point belongs.
Name		The name, in clear text, of the Metering Grid Area.
«Business entity» Aggregated Reception Station	Gas	An administrative entity that represents one or more Reception Stations for gas where the gas quality is regarded to be the same. <b>Dependency:</b> Use either Aggregated Reception Station or Calorific Value Area.
Identification		The unique identification of the Aggregated Reception Station to which this Accounting Point belongs.
Name		The name, in clear text, of the Aggregated Reception Station.
«Business entity» Calorific Value Area	Gas	A set of Accounting Points where the calorific value for the quality of supplied gas is assumed to be the same.
Identification		The unique identification of the Calorific Value Area to which this Accounting Point belongs.
Energy Label		A class indicating the origin of the energy produced at this Accounting Point
Technology		An indication of the technology of the energy production, or part of the energy production, which is potentially fed into the grid at this Accounting Point.
Fuel		An indication of the source (fuel) used for the energy production, or part of the energy production, which is potentially fed into the grid at this Accounting Point.
AP physical characteristics		The relevant physical characteristics of this Accounting Point.
Connection status		A code specifying if the installation of the Accounting Point is physically connected to the grid and energy flow is possible.
Disconnection method		An indication of how the Accounting Point is physically connected or disconnected.

<sup>24</sup> The definition is simplified version of the definition in the ebIX®, EFET and ENTSO-E Harmonised Role model [3].

Class/attribute	Sector 20	Description
Capacity of the Accounting Point		<p>Capacity of the Accounting Point, being the maximum physical capacity of (the connection to the installation of) the Accounting Point.</p> <p>For electricity, the maximum capacity for the Accounting Point is given in kW or MW or calculated from the nominal voltage level, number of phases and current limitations. The “Capacity of an Accounting Point” can be sent as the calculated capacity in kW or MW and/or as a combination of:</p> <ul style="list-style-type: none"> <li>• Number of phases</li> <li>• Fuse size</li> <li>• Voltage level</li> </ul>
Capacity of the Accounting Point M measure unit		<p>The measure unit used for the capacity of the Accounting Point. For gas the maximum capacity for the Accounting Point is given in m<sup>3</sup>/hour, usually determined by the physical constraints of the (nozzles in the) Meter.</p>
Number of phases	Elec	The number of phases in the Accounting Point, either 1 or 3.
Current limitation	Elec	The current limitation, i.e. maximum current or fuse size, for the Accounting Point in Ampere
Current limitation measure unit	Elec	The measure unit used for the current limitation, i.e. Ampere
Voltage level	Elec	A code specifying the voltage level of the grid where the installation of the Accounting Point is connected.
Pressure level	Gas	A code specifying the gas pressure in the grid where the installation of the Accounting Point is connected.
Energy volume information		Characteristics of the energy volume for this Accounting Point for reconciliation purposes.
Product Type		A code specifying the energy product for the estimated annual volume.
Standard Load Profile		The standard load profile for this Accounting Point.
Direction		A code specifying the direction of the energy in the estimated annual volume for this Accounting Point, such as consumption, production or both.
Consumption detail		An indication of the kind of consumption at this Accounting Point, such as production unit’s own consumption, pumped or disconnectable consumption.
Estimated annual volume		The energy volume used for profiled nomination and allocation for this Accounting Point.
Quantity		The estimated annual volume for the specified time frame.

Class/attribute	Sector 20	Description
Meter Time Frame Type	Elec	A code specifying the tariff time frame for this estimated annual volume.
Measure Unit		The unit of measure used for the Estimated Annual Volume.
AP Billing characteristics		The relevant billing characteristics of this Accounting Point.
Charge ID		The unique identification of the Charge applicable for this Accounting Point.
Charge group ID		The unique identification of the Charge group applicable for this Accounting Point. A Charge group is a set of Charges valid for a set of Accounting Point with similar characteristics.
AP measurement characteristics		Characteristics of the measurement reporting from this Accounting Point.
Reporting interval		<p>The time between publications of meter readings from the Metered Data Administrator, expressed in compliance with ISO 8601 in the following format:</p> <p style="text-align: center;">PnYnMnDTnHnMnS.</p> <p>For example <b>PT1D</b> for daily publications.</p>
Reporting resolution		<p>The length of each observation that is reported to the market from the Metered Data Administrator, expressed in compliance with ISO 8601 in the following format:</p> <p style="text-align: center;">PnYnMnDTnHnMnS.</p> <p>For example <b>PT1H</b> for hourly resolution.</p>
Register resolution		<p>The length of each observation that is registered in the Register in the Meter, expressed in compliance with ISO 8601 in the following format:</p> <p style="text-align: center;">PnYnMnDTnHnMnS.</p> <p>For example <b>PT15M</b> for 15 minutes resolution.</p>
Metering method		A code specifying how the energy volumes are established for this Accounting Point, such as continuous- non-continuous- or not-metered.
Scheduled meter reading date		The indication of when the regular meter reading is scheduled.

### 4.6 Reject request change Accounting Point characteristics by Grid Company (Class Diagram)

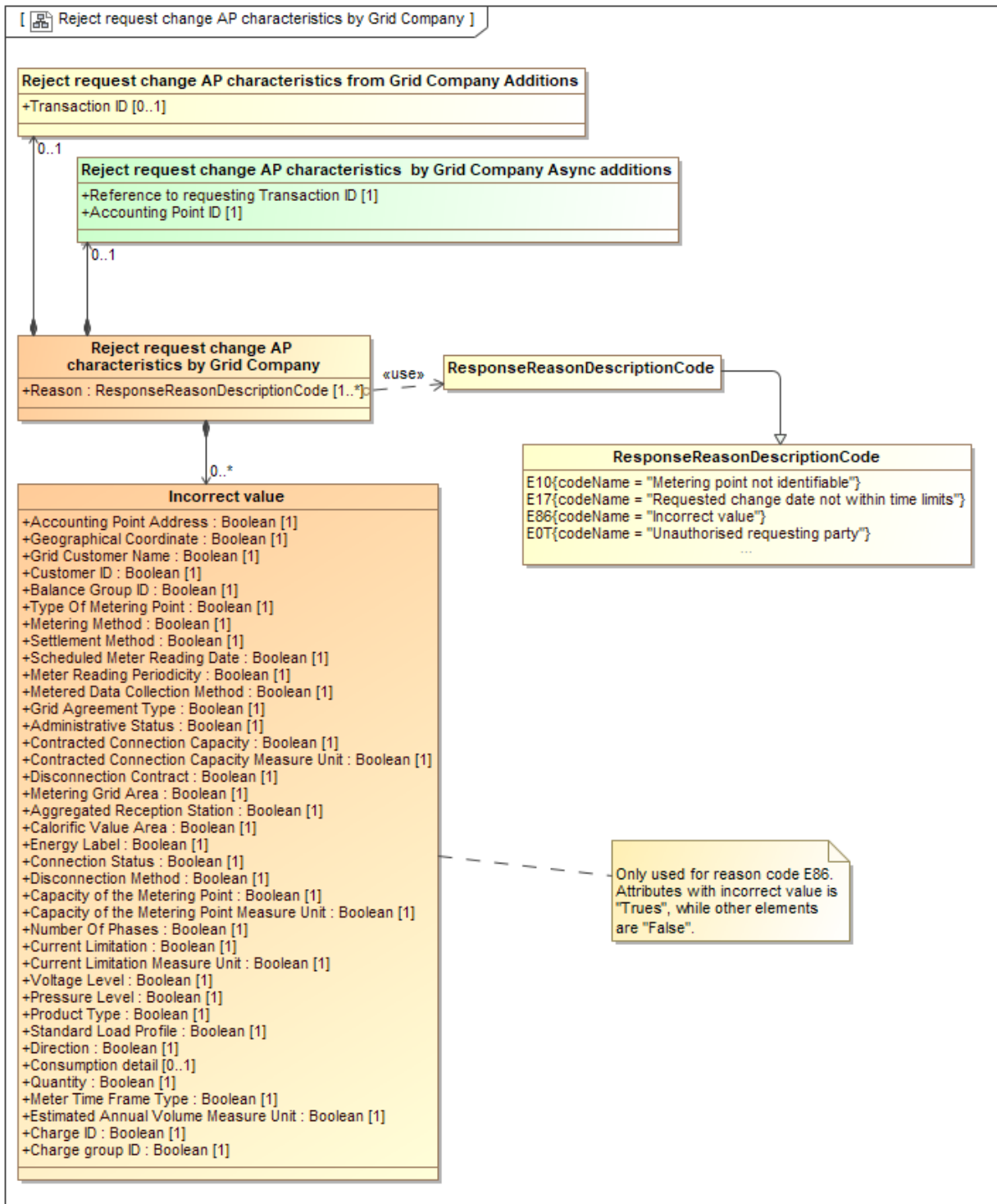

Figure 20 Reject request change Accounting Point characteristics by Grid Company

#### 4.6.1 Element definitions: Reject request change Accounting Point characteristics by Grid Company

Class/attribute	Sector <sup>25</sup>	Description
«Business entity» Reject request change Accounting Point Characteristics by Grid Company		The information set sent from the Metering Point Administrator to the Grid Company (Content Responsible Role) when rejecting a request for Change Accounting Point characteristics.
Reason		A code specifying (one of) the reason(s) for the rejection of the request for Change Accounting Point characteristics.
Incorrect value		Attributes with incorrect value is "Trues", while other elements are "False". Only used for reason code "E86, Incorrect value".
Accounting Point Address		Incorrect address of the Accounting Point.
Geographical Coordinate		Incorrect set of geographical coordinates of this Accounting Point.
Grid Customer Name		Incorrect name of the Grid Customer.
Grid Customer ID		Incorrect identification of the Customer at the Accounting Point.
Balance Group ID		Incorrect identification of the Balance Group to which this Accounting Point belongs.
Type of Accounting Point		Incorrect code specifying the direction of the active energy flow in this Accounting Point, such as consumption, production or combined.
Metering Method		Incorrect code specifying how the energy volumes are established for this Accounting Point, such as continuous, non-continuous or not-metered.
Settlement Method		Incorrect code specifying how the energy volumes are treated for settlement for this Accounting Point, such as profiled or non-profiled <sup>26</sup> .
Scheduled Meter Reading Date		Incorrect indication of when the regular meter reading is scheduled.
Meter Reading Periodicity		Incorrect length of time between the meter readings.
Metered Data Collection Method		Incorrect code specifying how a Metered Data Collector collects data from the Meter for this Accounting Point, such as Automatic or Manually.

<sup>25</sup> It is assumed that Accounting Points are uniquely dedicated to either electricity or to gas.

<sup>26</sup> A profiled Accounting Point is always a part of the reconciliation process as opposed to non-profiled.

Class/attribute	Sector <sup>25</sup>	Description
Grid Agreement Type		Incorrect specification of type of grid contract, such as if the contract is directly between the Grid Company and the Grid Customer, or through the Energy Supplier.
Administrative Status		Incorrect code specifying whether (or not) the Accounting Point is part of the imbalance settlement.
Contracted Connection Capacity		Incorrect quantitative information about the capacity of the connection that is contracted for the Accounting Point.
Contracted Connection Capacity Measure Unit		Incorrect unit of measure used for the Contracted Connection Capacity.
Disconnection Contract		Incorrect Flexibility Contract.
Metering Grid Area		Incorrect Metering Grid Area the Accounting Point belongs to.
Aggregated Reception Station		Incorrect Aggregated Reception Station.
Calorific Value Area		Incorrect Calorific Value Area is an error in the predefined set of Accounting Points for which the same established calorific value is applied.
Energy Label		Incorrect Energy Label, which indicating the origin of the energy produced at this Accounting Point
Connection Status		Incorrect code specifying if the installation of the Accounting Point is physically connected to the grid and energy flow is possible.
Disconnection Method		Incorrect indication of how the Accounting Point is physically connected or disconnected.
Capacity of the Accounting Point		Incorrect Capacity of the Accounting Point, being the maximum physical capacity of (the connection to the installation of) the Accounting Point.
Capacity of the Accounting Point Measure Unit		Incorrect measure unit used for the capacity of the Accounting Point. For gas the maximum capacity for the Accounting Point is given in m <sup>3</sup> /hour, usually determined by the physical constraints of the (nozzles in the) Meter.
Number of phases	Elec	Incorrect number of phases in the Accounting Point, either 1 or 3.
Current limitation	Elec	Incorrect current limitation, i.e. maximum current or fuse size, for the Accounting Point in Ampere

Class/attribute	Sector <sup>25</sup>	Description
Current limitation Measure Unit	Elec	Incorrect measure unit used for the current limitation, i.e. Ampere
Voltage Level	Elec	Incorrect code specifying the voltage level of the grid where the installation of the Accounting Point is connected.
Pressure level	Gas	Incorrect code specifying the gas pressure in the grid where the installation of the Accounting Point is connected.
Product Type		Incorrect code specifying the energy product for the estimated annual volume.
Standard Load Profile		Incorrect standard load profile for this Accounting Point.
Direction		Incorrect code specifying the direction of the energy in the estimated annual volume for this Accounting Point, such as consumption, production or both.
Consumption detail		An indication of the kind of consumption at this Accounting Point, such as production unit's own consumption, pumped or disconnectable consumption.
Estimated annual volume Quantity		Incorrect estimated annual volume for the specified time frame.
Meter Time Frame Type	Elec	Incorrect code specifying the tariff time frame for this estimated annual volume.
Estimated Annual Volume Measure Unit		Incorrect unit of measure used for the Estimated Annual Volume.
Charge ID		Incorrect identification of the Charge applicable for this Accounting Point.
Charge group ID		Incorrect identification of the Charge group applicable for this Accounting Point. A Charge group is a set of Charges valid for a set of Accounting Point with similar characteristics.
Reject request change Accounting Point Characteristics Additions		Additional information related to rejecting the request for Change Accounting Point characteristics, to be agreed on a national level.
Transaction ID		The unique identification of this set of information given by the Metering Point Administrator.
Reject request Accounting Point Characteristics Async Additions		Additional information, related to the rejection of the request for Change Accounting Point characteristics, needed when using asynchronous communication.
Reference to requesting Transaction ID		The Transaction ID from the request, where this is the response for, given by the Initiator.

Class/attribute	Sector <sup>25</sup>	Description
Accounting Point ID		The unique identification of the Accounting Point.



### 4.7 Request change Accounting Point characteristics by Energy Supplier (Class Diagram)

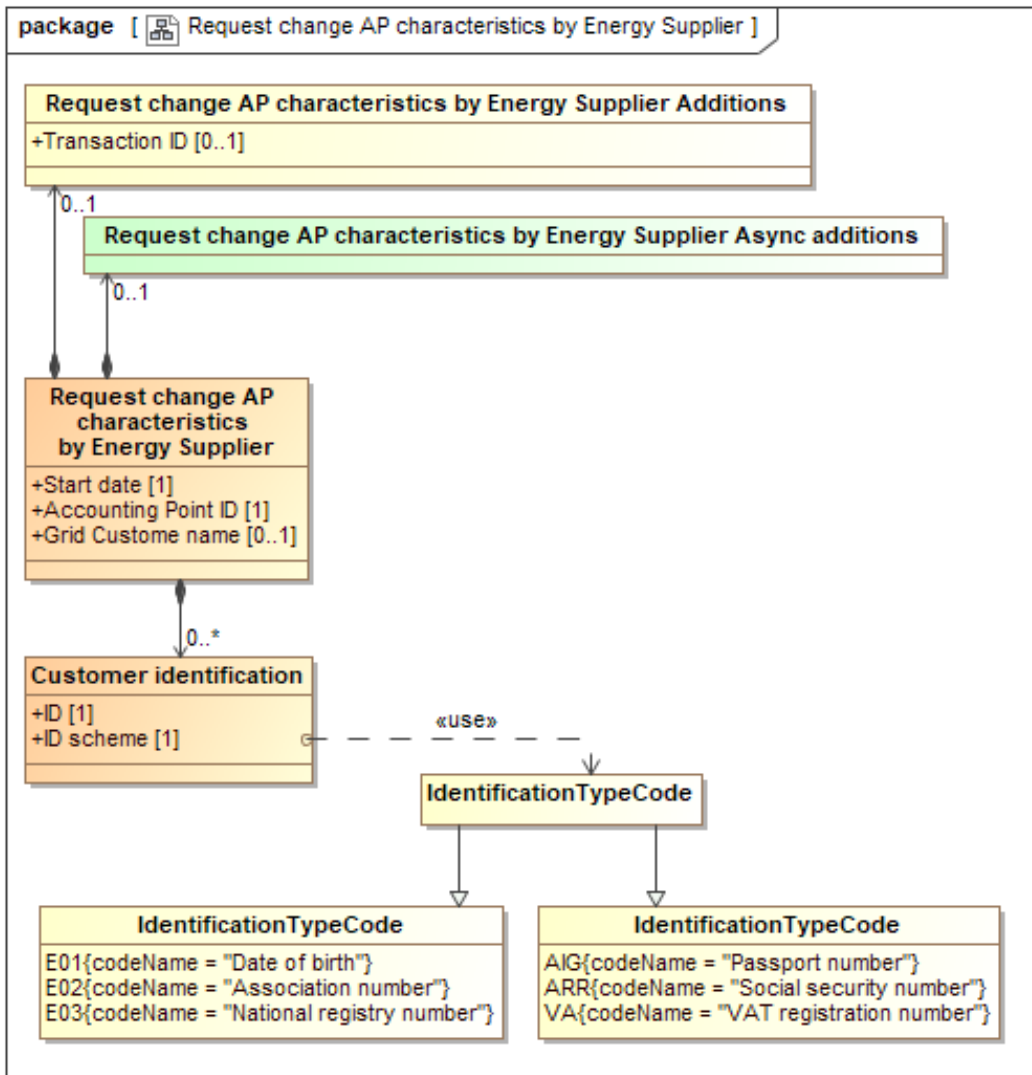

Figure 21 Request change Accounting Point characteristics by Energy Supplier

#### 4.7.1 Element definitions: Request change Accounting Point characteristics by Energy Supplier

Class/attribute	Sector <sup>27</sup>	Description
«Business entity» Request change Accounting Point characteristics by Energy Supplier		The information set to be sent from an Energy Supplier to the Metering Point Administrator when requesting Change Accounting Point characteristics.
Start date		The date when the updated characteristics sent in this business document become or became valid.
Accounting Point ID		The unique identification of the Accounting Point the update is requested for.
Grid Customer name		The name of the Customer that has the contract for grid access and transport of energy for this Accounting Point.
Customer identification		The Identification of a Customer
ID		The unique identification of the Customer at the Accounting Point.
ID scheme		The Identification scheme used for the identification of the Customer in question
Request change Accounting Point characteristics by Energy Supplier Additions		Information related to the document exchange, to be agreed on a national level.
Transaction ID		The unique identification of this set of information, given by the Initiator.
Request change Accounting Point characteristics by Energy Supplier Async Additions		Information related to the document exchange, needed when using asynchronous communication.

<sup>27</sup> It is assumed that Accounting Points are uniquely dedicated to either electricity or to gas.

### 4.8 Confirm request change Accounting Point characteristics by Energy Supplier (Class Diagram)

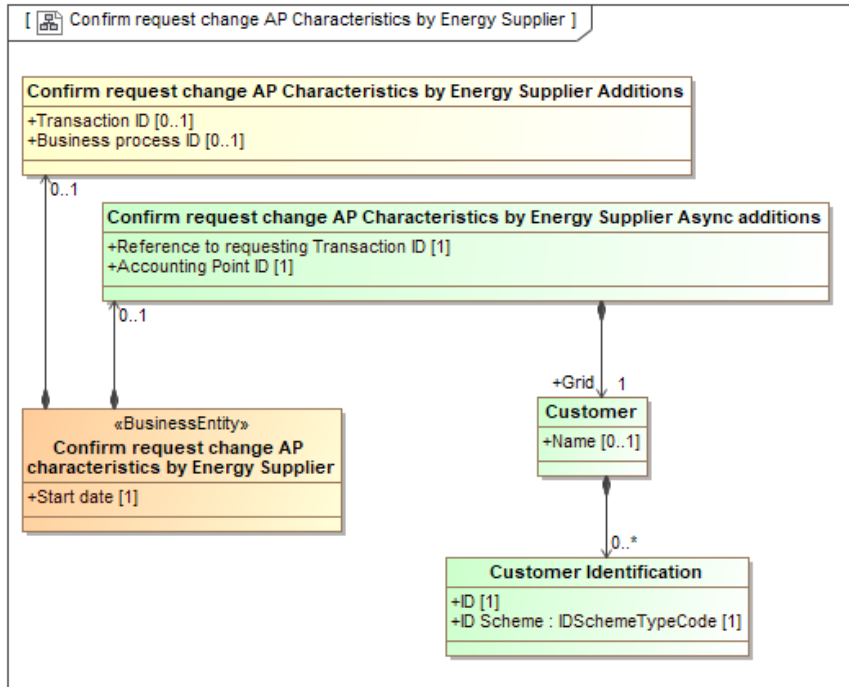

Figure 22 Confirm request change Accounting Point characteristics by Energy Supplier

**Note:**

- The attributes and attribute values in the confirmation shall be the same as in the corresponding request, therefore we allow us to only show the updated classes and attributes, hence skipping the coded values in the class diagram above.

#### 4.8.1 Element definitions: Confirm request change Accounting Point characteristics by Energy Supplier

Class/attribute	Sector <sup>28</sup>	Description
<b>«Business entity»</b> Confirm request change Accounting Point characteristics by Energy Supplier		The information set to be sent from the Metering Point Administrator to the Energy Supplier when confirming a request for change of Meter Accounting Point characteristics.
Start Date		The confirmed start date for this change.
Confirm request change Accounting Point characteristics by Energy Supplier Additions		Information related to the document exchange, to be agreed on a national level.
Transaction ID		The unique identification of this set of information, given by the Initiator.
Business Process ID		The unique identification of the instance of the process that this transaction is a part of.
Confirm request change Accounting Point characteristics by Energy Supplier Async Additions		Information related to the document exchange, needed when using asynchronous communication.
Accounting Point ID		The unique identification of the Accounting Point the update is confirmed for.
Reference to Requesting Transaction ID		The Transaction ID from the request.
Grid Customer		The Customer that has the contract for grid access and transport of energy for this Accounting Point
Name		The name of this grid Customer
Customer Identification		The Identification of a Customer
ID		The unique identification of the Customer at the Accounting Point.
ID Scheme		The Identification scheme used for the identification of the Customer in question

<sup>28</sup> It is assumed that Accounting Points are uniquely dedicated to either electricity or to gas.

### 4.9 Reject request change Accounting Point characteristics by Energy Supplier (Class Diagram)

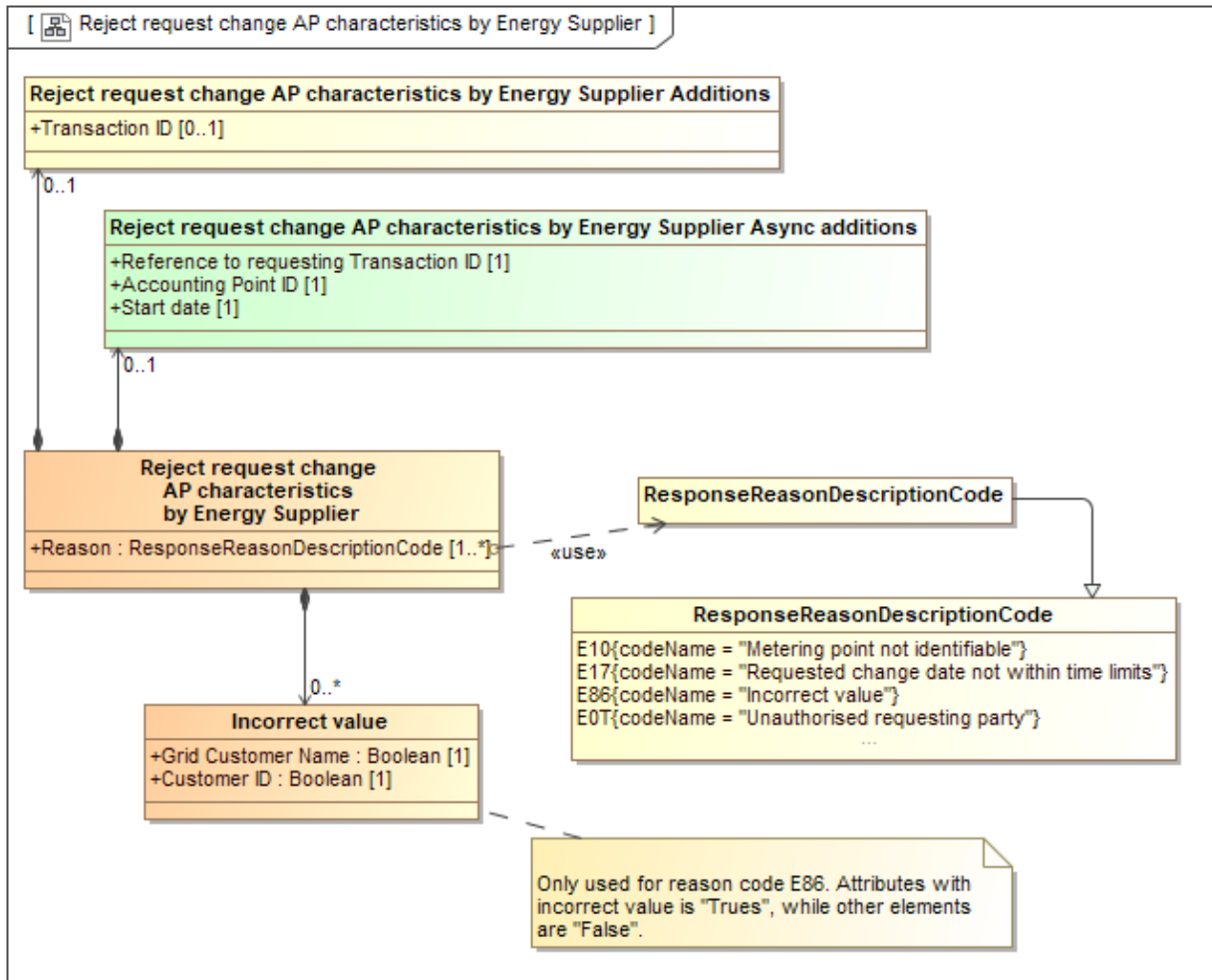

Figure 23 Reject request change Accounting Point characteristics by Energy Supplier

#### 4.9.1 Element definitions: Reject request change Accounting Point characteristics by Energy Supplier

Class/attribute	Sector <sup>29</sup>	Description
«Business entity» Reject request change Accounting Point Characteristics by Energy Supplier		The information set sent from the Metering Point Administrator to the Energy Supplier when rejecting a request for Change Accounting Point characteristics.
Reason		A code specifying (one of) the reason(s) for the rejection of the request for Change Accounting Point characteristics.
Incorrect value		Attributes with incorrect value is "Trues", while other elements are "False". Only used for reason code "E86, Incorrect value".
Grid Customer Name		Incorrect name of the Grid Customer.
Grid Customer ID		Incorrect identification of the Customer at the Accounting Point.
Reject request change Accounting Point Characteristics by Energy Supplier Additions		Additional information related to rejecting the request for Change Accounting Point characteristics, to be agreed on a national level.
Transaction ID		The unique identification of this set of information given by the Accounting Point Administrator.
Reject request change Accounting Point Characteristics by Energy Supplier Async Additions		Additional information, related to the rejection of the request for Change Accounting Point characteristics, needed when using asynchronous communication.
Reference to requesting Transaction ID		The Transaction ID from the request, where this is the response for, given by the Initiator.
Accounting Point ID		The unique identification of the Accounting Point the requested update is rejected for.
Start Date		The requested start date for this change.

<sup>29</sup> It is assumed that Accounting Points are uniquely dedicated to either electricity or to gas.

### 4.10 Request update Accounting Point characteristics (Class Diagram)

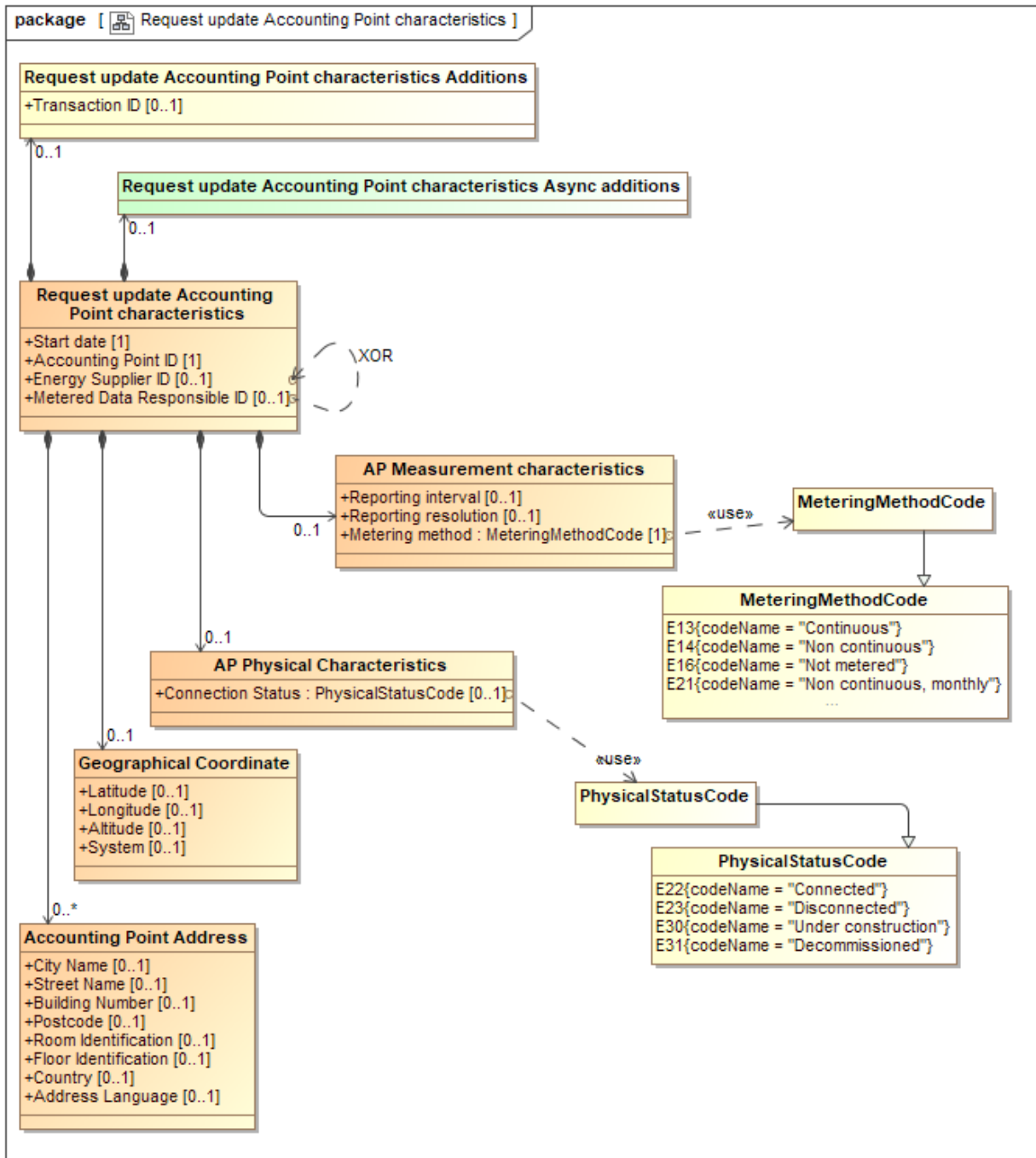

Figure 24 Request update Accounting Point characteristics

#### 4.10.1 Element definitions: Request update Accounting Point characteristics

Class/attribute	Sector <sup>30</sup>	Description
«Business entity» Request update Accounting Point characteristics		The information set to be sent from an Initiator for Update, i.e. Energy Supplier or Metered Data Responsible, to the Metering Point Administrator when requesting update of Accounting Point characteristics in an Accounting Point.
Start date		The requested date from the initiator, when the changes to the Accounting Point characteristics are to become valid.
Accounting Point ID		The unique identification of the Accounting Point the request is aimed for.
Energy Supplier ID		The unique identification of the Energy Supplier that requests update of Accounting Point characteristics in the Accounting Point.
Metered Data Responsible ID		The unique identification of the Metered Data Responsible that requests update of Accounting Point characteristics in the Accounting Point.
Accounting Point Address		Proposed updated address of the Accounting Point.  May be repeated if more than one language is used nationally.
City Name		The name, expressed as text, of the city, town or village of this address.
Street Name		The name, expressed as text, of this street or thoroughfare of this address.
Building Number		The number, expressed as text, of the building or house on this street at this address. <sup>31</sup>
Postcode		The code specifying the postcode of this address.
Room Identification		The identification, expressed as text, of the room, suite, office or apartment as part of this address.
Floor Identification		The identification by name or number, expressed as text, of the floor in the building as part of this address.
Country		The unique identifier of the country for this address (Reference ISO 3166 and UN/ECE Rec 3).
Address language		The language in which the address is specified.
Geographical Coordinate		Proposed update of the set of geographical coordinates of this Accounting Point.

<sup>30</sup> It is assumed that Accounting Points are uniquely dedicated to either electricity or to gas.

<sup>31</sup> The Building Number may include a “Building Number Extension”, such as one or more character making the address unique.



Class/attribute	Sector <sup>30</sup>	Description
Latitude		The measure of the latitude as an angular distance north or south from the Equator meridian to the meridian of this Accounting Point for this geographical coordinate. (Reference ISO 6709).
Longitude		The measure of the longitude as an angular distance east or west from the Greenwich meridian to the meridian of this Accounting Point (Reference ISO 6709).
Altitude <sup>32</sup>	Gas	The measure of the altitude that reflects the vertical elevation of this Accounting Point above a surface for this geographical coordinate (Reference ISO 6709).
System		The unique identifier of the reference system used for measuring this geographical coordinate.
AP measurement characteristics		Proposed characteristics of the measurement reporting from this Accounting Point.
Reporting interval		The time between publications of meter readings from the Metered Data Administrator, expressed in compliance with ISO 8601 in the following format:  PnYnMnDTnHnMnS.  For example <b>PT1D</b> for daily publications.
Reporting resolution		The length of each observation that is reported to the market from the Metered Data Administrator, expressed in compliance with ISO 8601 in the following format:  PnYnMnDTnHnMnS.  For example <b>PT1H</b> for hourly resolution.
Metering method		A code specifying how the energy volumes are established for this Accounting Point, such as continuous- non-continuous- or not-metered.
AP Physical Characteristics		Proposed update of the relevant physical characteristics of this Accounting Point.
Connection Status		The code specifying if the installation of the Accounting Point is physically connected to the grid and energy flow is possible.
Request update Accounting Point characteristics Additions		Information related to the document exchange, to be agreed on a national level.
Transaction ID		The unique identification of this set of information, given by the Initiator.

<sup>32</sup> The altitude of the meter may be used in the gas sector for correction purposes.

Class/attribute	Sector <sup>30</sup>	Description
Request update Accounting Point characteristics Async Additions		Information related to the document exchange, needed when using asynchronous communication.

### 4.11 Confirm request update Accounting Point characteristics (Class Diagram)

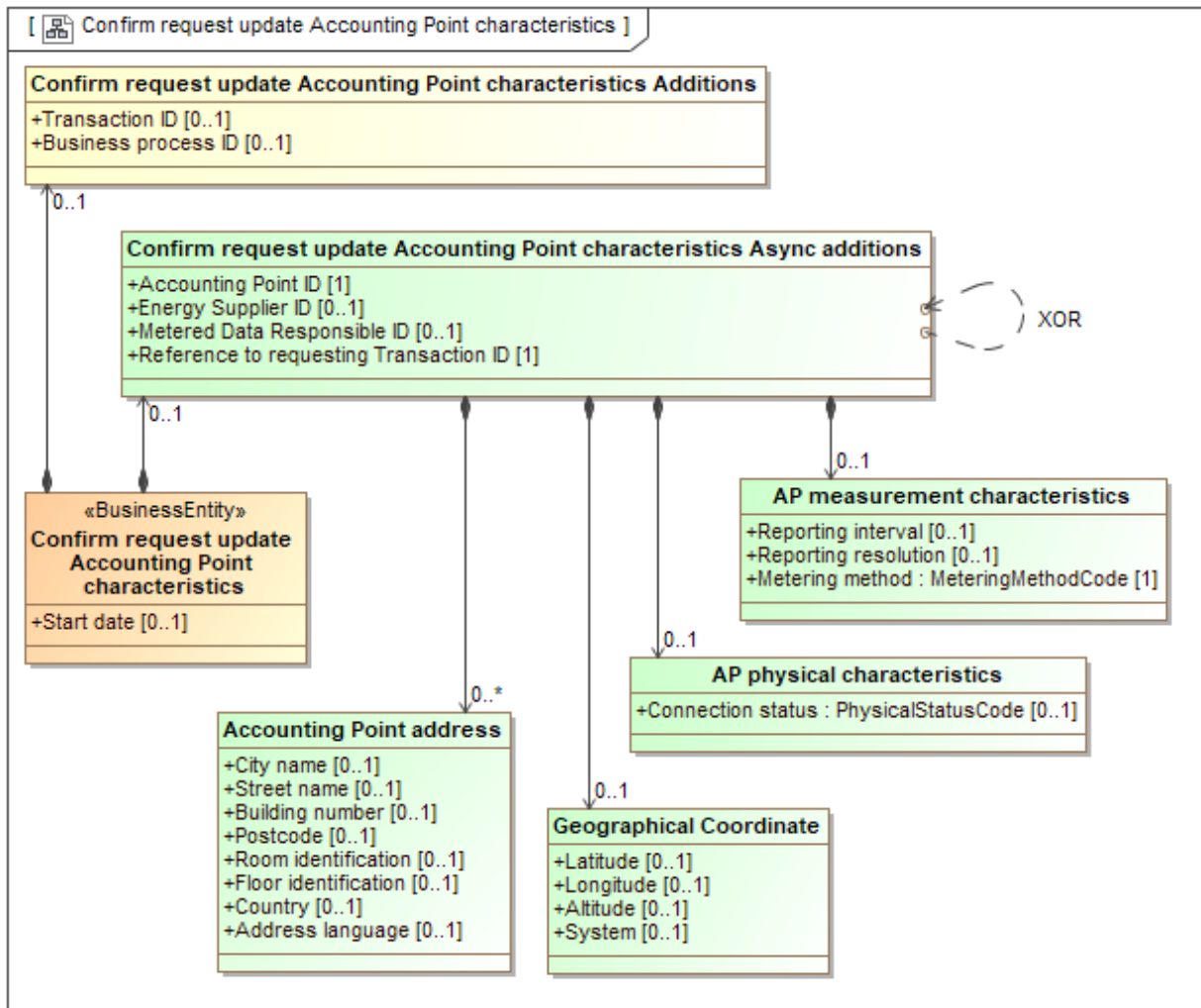

Figure 25 Confirm request update Accounting Point characteristics

**Note:**

- The attributes and attribute values in the confirmation shall be the same as in the corresponding request, therefore we allow us to only show the updated classes and attributes, hence skipping the coded values in the class diagram above.

## 4.11.1 Element definitions: Confirm request update Accounting Point characteristics

Class/attribute	Sector <sup>33</sup>	Description
«Business entity» Confirm request update Accounting Point characteristics		The information set to be sent from the Metering Point Administrator to the Initiator for Update, i.e. Energy Supplier or Metered Data Responsible, when confirming a request for update of Accounting Point characteristics.
Start date		The confirmed start date for this requested update of Accounting Point characteristics for this Accounting Point. <b>Dependency:</b> <ul style="list-style-type: none"> <li>The usage of Start date is dependent on national rules.</li> </ul>
Confirm request update Accounting Point characteristics Additions		Information related to the document exchange, to be agreed on a national level.
Transaction ID		The unique identification of this set of information, given by the Initiator.
Business process ID		The unique identification of the instance of the process that this transaction is a part of.
Confirm request update Accounting Point characteristics Async Additions		Information related to the document exchange, needed when using asynchronous communication.
Reference to requesting Transaction ID		The Transaction ID from the request.
Accounting Point ID		The unique identification of the Accounting Point the update of characteristics is confirmed for.
Energy Supplier ID		The unique identification of the Energy Supplier responsible for energy supply for this Accounting Point that requested the update.
Metered Data Responsible ID		The unique identification of the Metered Data Responsible, responsible for the metering of this Accounting Point that requested the update.
Accounting Point address		The confirmed address of the Accounting Point.  May be repeated if more than one language is used nationally.
City name		The name, expressed as text, of the city, town or village of this address.

<sup>33</sup> It is assumed that Accounting Points are uniquely dedicated to either electricity or to gas.

Class/attribute	Sector <sup>33</sup>	Description
Street name		The name, expressed as text, of this street or thoroughfare of this address.
Building number		The number, expressed as text, of the building or house on this street at this address. <sup>34</sup>
Postcode		The code specifying the postcode of this address.
Room identification		The identification, expressed as text, of the room, suite, office or apartment as part of this address.
Floor identification		The identification by name or number, expressed as text, of the floor in the building as part of this address.
Country		The unique identifier of the country for this address (Reference ISO 3166 and UN/ECE Rec 3).
Address language		The language in which the address is specified, using ISO 639-1 two-digit language code
Geographical coordinate		The confirmed set of geographical coordinates of this Accounting Point.
Latitude		The measure of the latitude as an angular distance north or south from the Equator meridian to the meridian of this Accounting Point for this geographical coordinate. (Reference ISO 6709).
Longitude		The measure of the longitude as an angular distance east or west from the Greenwich meridian to the meridian of this Accounting Point (Reference ISO 6709).
Altitude <sup>35</sup>	Gas	The measure of the altitude that reflects the vertical elevation of this Accounting Point above a surface for this geographical coordinate (Reference ISO 6709).
System		The unique identifier of the reference system used for measuring this geographical coordinate.
AP measurement characteristics		Confirmed characteristics of the measurement reporting from this Accounting Point.
Reporting interval		The time between publications of meter readings from the Metered Data Administrator, expressed in compliance with ISO 8601 in the following format:  PnYnMnDTnHnMnS.  For example <b>PT1D</b> for daily publications.

<sup>34</sup> The Building Number may include a “Building Number Extension”, such as one or more character making the address unique.

<sup>35</sup> The altitude of the meter may be used in the gas sector for correction purposes.

Class/attribute	Sector <sup>33</sup>	Description
Reporting resolution		<p>The length of each observation that is reported to the market from the Metered Data Administrator, expressed in compliance with ISO 8601 in the following format:</p> <p style="text-align: center;">PnYnMnDTnHnMnS.</p> <p>For example <b>PT1H</b> for hourly resolution.</p>
Metering method		<p>A code specifying how the energy volumes are established for this Accounting Point, such as continuous- non-continuous- or not-metered.</p>
AP physical characteristics		<p>The confirmed relevant physical characteristics of this Accounting Point.</p>
Connection status		<p>A code specifying if the installation of the Accounting Point is physically connected to the grid and energy flow is possible.</p>

### 4.12 Reject request update Accounting Point characteristics (Class Diagram)

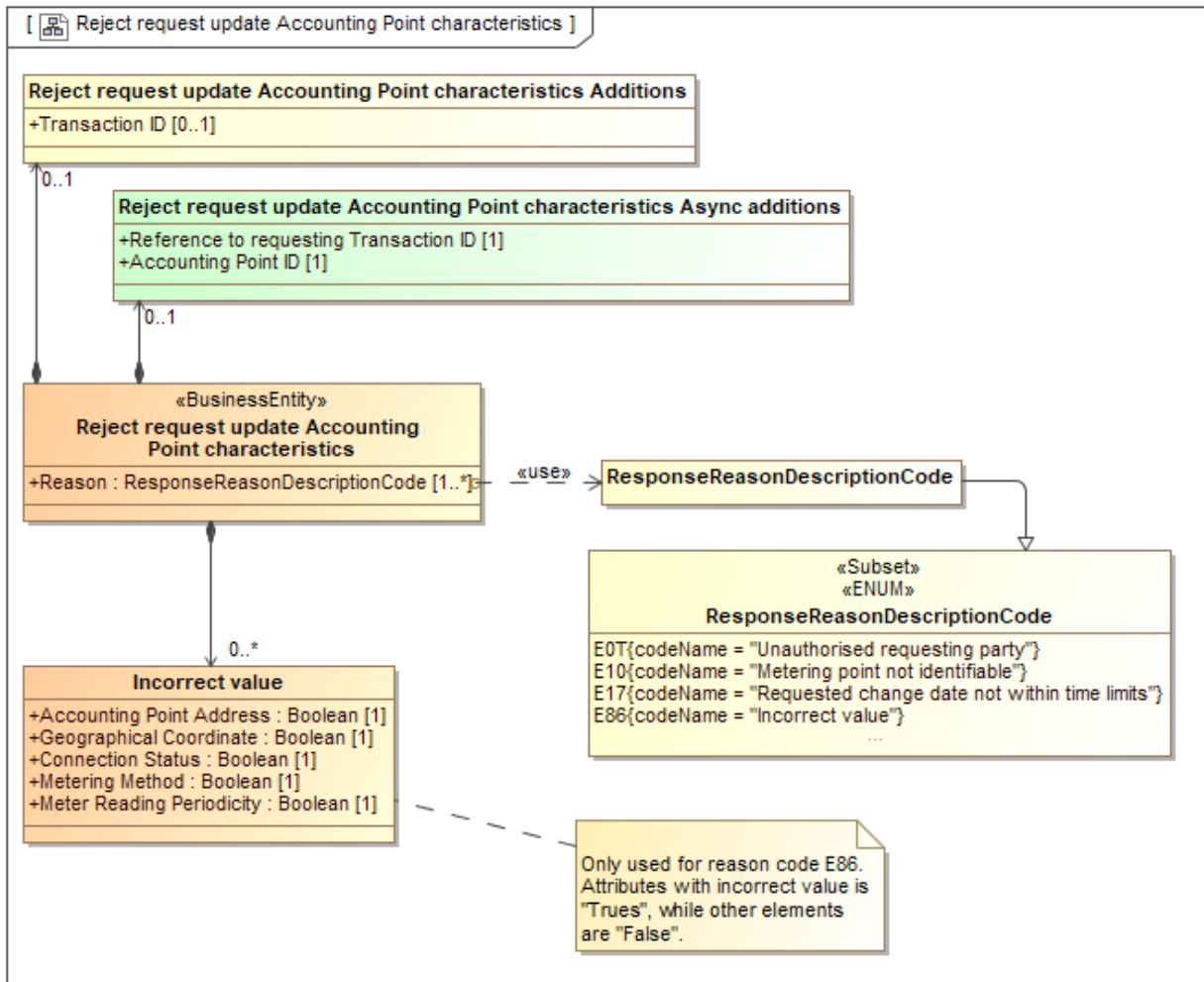

Figure 26 Reject request update Accounting Point characteristics

#### 4.12.1 Element definitions: Reject request update Accounting Point characteristics

Class/attribute	Sector <sup>36</sup>	Description
«Business entity» Reject Request update Accounting Point characteristics		The information set sent from the Grid Company to the Initiator for Update, i.e. Energy Supplier or Metered Data Responsible, when rejecting a request for update of Accounting Point characteristics.
Reason		A code specifying (one of) the reason(s) for the rejection of the request for update of Accounting Point characteristics.
Incorrect value		Attributes with incorrect value is "True", while other elements are "False". Only used for reason code "E86, Incorrect value".
Accounting point address		Incorrect address of the Accounting Point.
Geographical coordinate		Incorrect set of geographical coordinates of this Accounting Point.
Metering method		Incorrect code specifying how the energy volumes are established for this Accounting Point, such as continuous, non-continuous or not-metered.
Meter reading periodicity		Incorrect length of time between the meter readings.
Connection status		Incorrect code specifying if the installation of the Accounting Point is physically connected to the grid and energy flow is possible.
Reject request update Accounting Point characteristics Additions		Additional information related to rejecting the request for update of Accounting Point characteristics, to be agreed on a national level.
Transaction ID		The unique identification of this set of information given by the Metering Point Administrator.
Reject request update Accounting Point characteristics Async Additions		Additional information, related to the rejection of the request for update of Accounting Point characteristics, needed when using asynchronous communication.
Reference to requesting Transaction ID		The Transaction ID from the request, where this is the response for, given by the Initiator.
Accounting Point ID		The unique identification of the Accounting Point the requested update of characteristics is rejected for.

<sup>36</sup> It is assumed that Accounting Points are uniquely dedicated to either electricity or to gas.



## Appendix A. Header and Context information for the class diagrams

### A.1. Header and Context Information attributes definitions

Class/attribute	Sector <sup>37</sup>	Description
Header and Context Information		The set of information specifying the information to be added to this payload to enable the exchange as a document.
Document Type		A code representing the document type used for the exchange of this set of information.
Business Reason		A code representing the business reason for the exchange of this set of information.
Ancillary Business Process Role		A code representing the market role taking part in this exchange together with the Responsible Role, responsible for the process/this exchange.

### A.2. Accounting Point characteristics

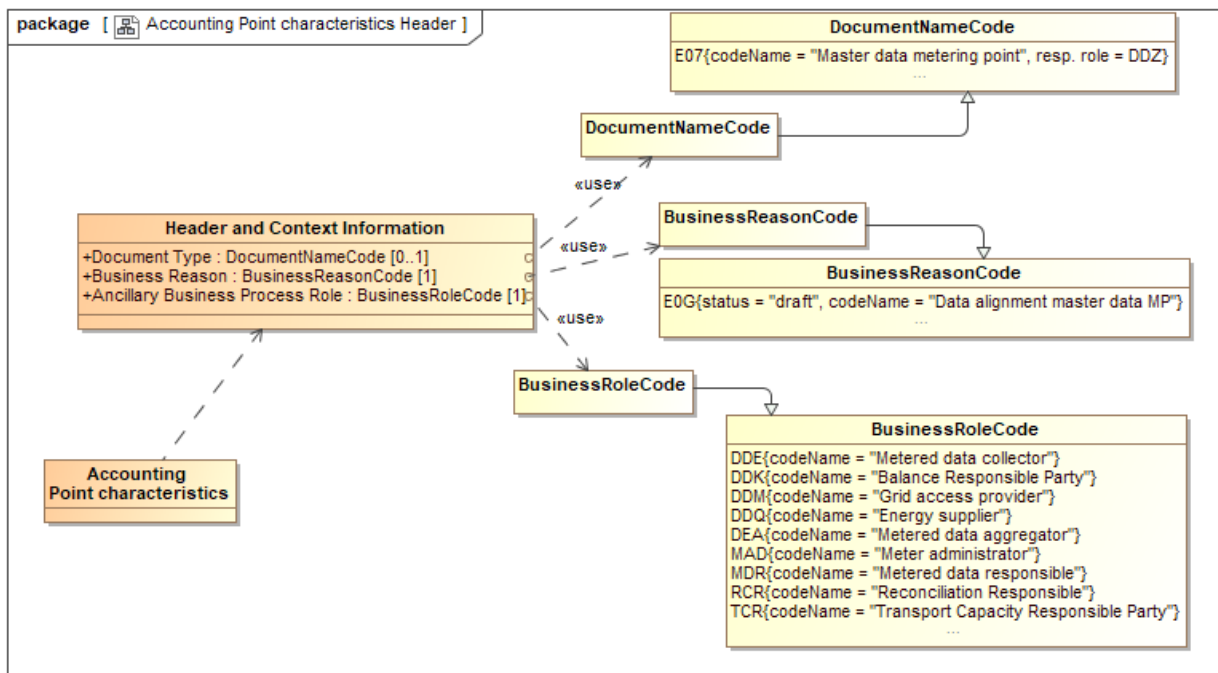

Figure 27 Class diagram: Header and Context information Accounting Point characteristics

<sup>37</sup> It is assumed that Accounting Points are uniquely dedicated to either electricity or to gas.

### A.3. Request Accounting Point characteristics

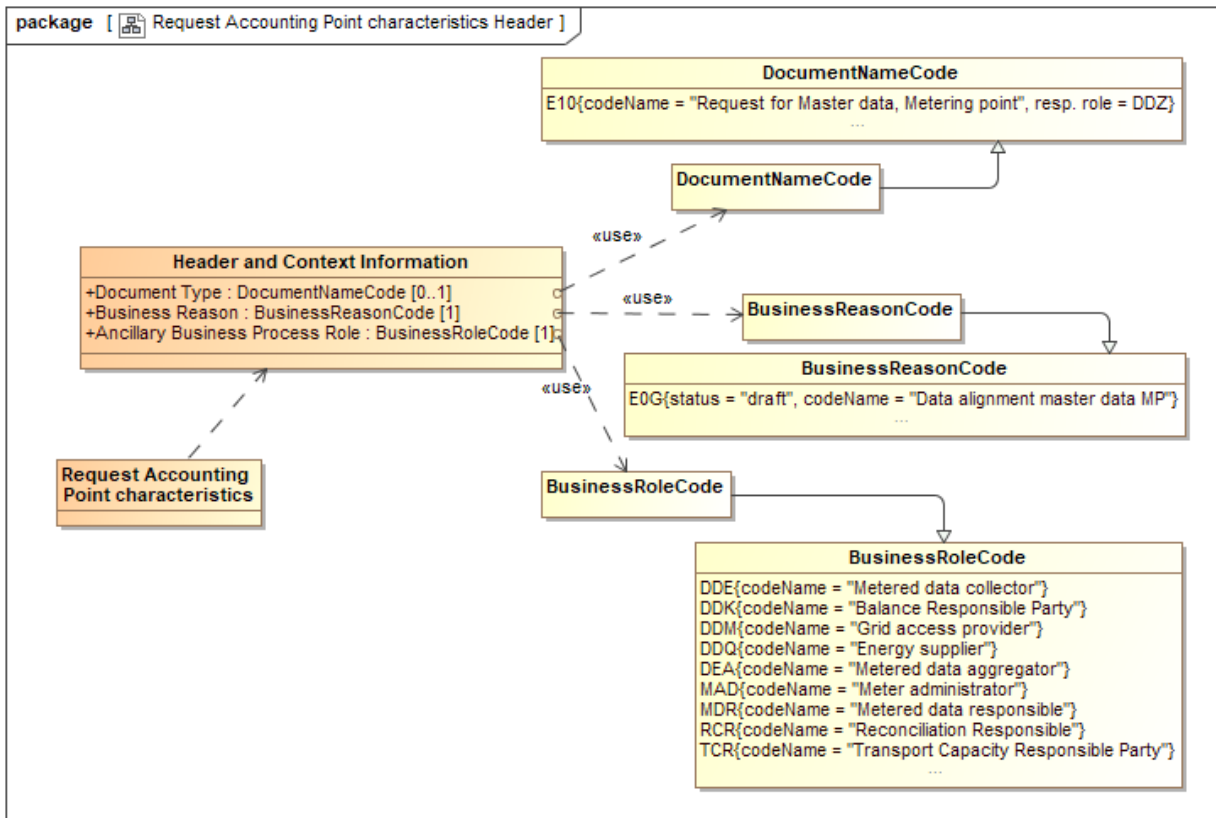

Figure 28 Class diagram: Header and Context information Request Accounting Point characteristics

### A.4. Reject Request Accounting Point characteristics

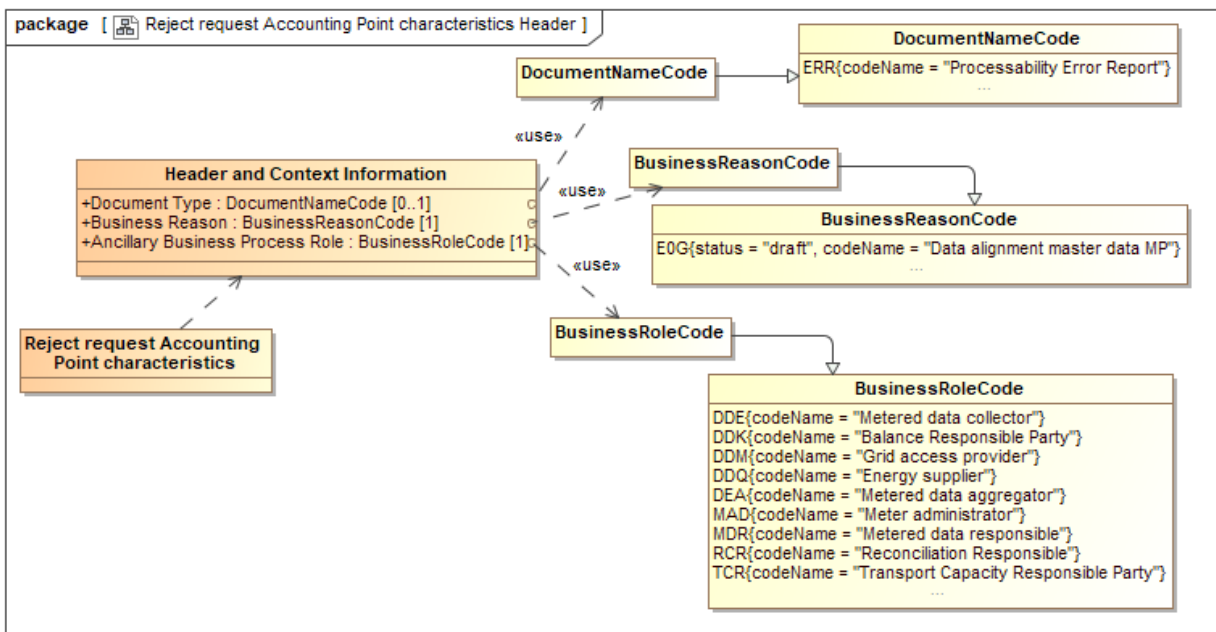

Figure 29 Class diagram: Header and Context information Reject Request Accounting Point characteristics

### A.5. Request update Accounting Point characteristics

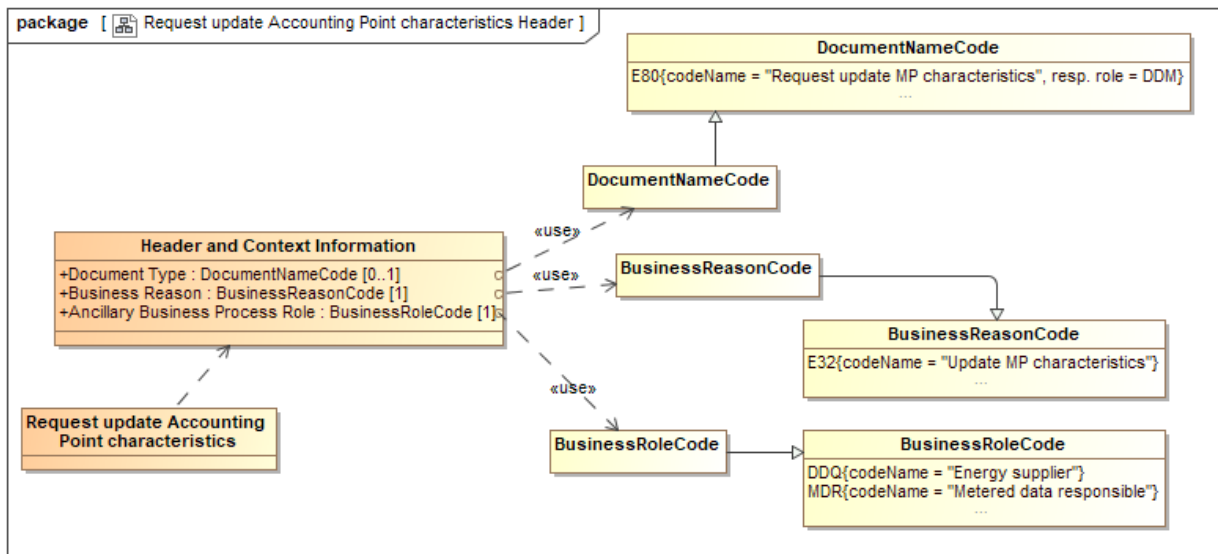

Figure 30 Class diagram: Header and Context information Request update Accounting Point characteristics

### A.6. Confirm Request update Accounting Point characteristics

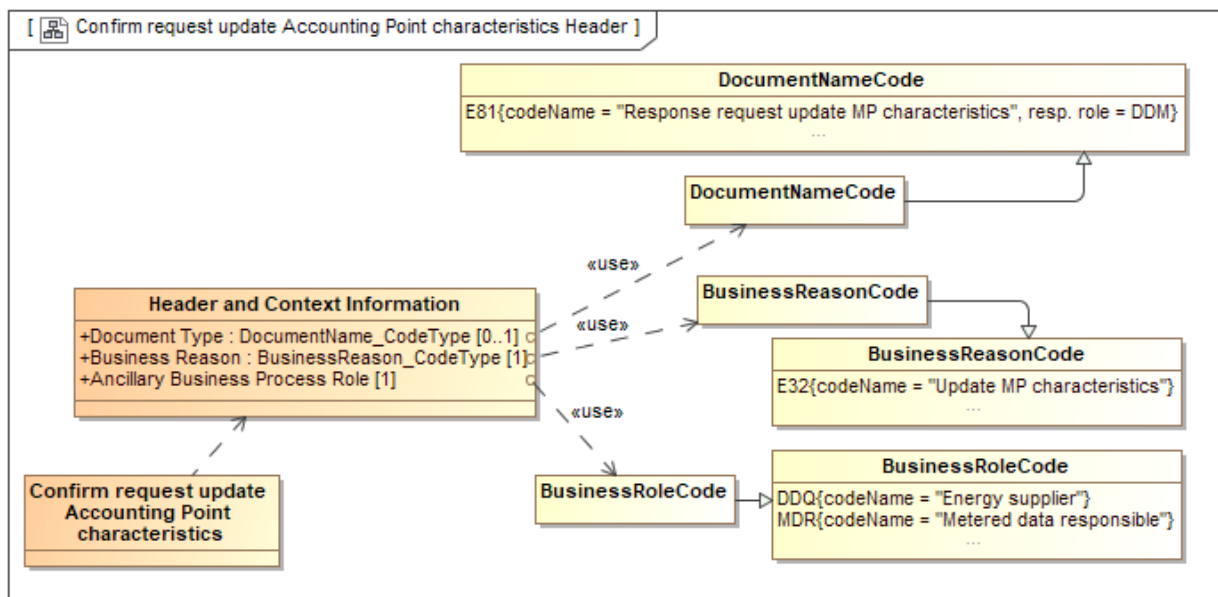

Figure 31 Class diagram: Header and Context information Confirm Request update Accounting Point characteristics

### A.7. Reject request update Accounting Point characteristics

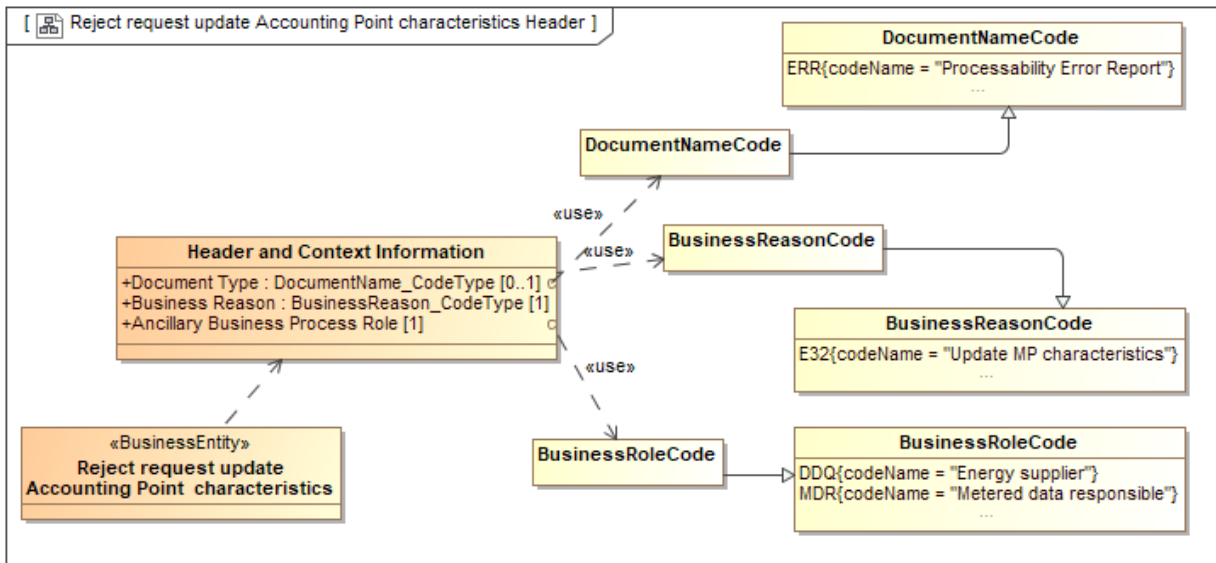

Figure 32 Class diagram: Header and Context information Reject request update Accounting Point characteristics

### A.8. Request change Accounting Point characteristics by Grid Company

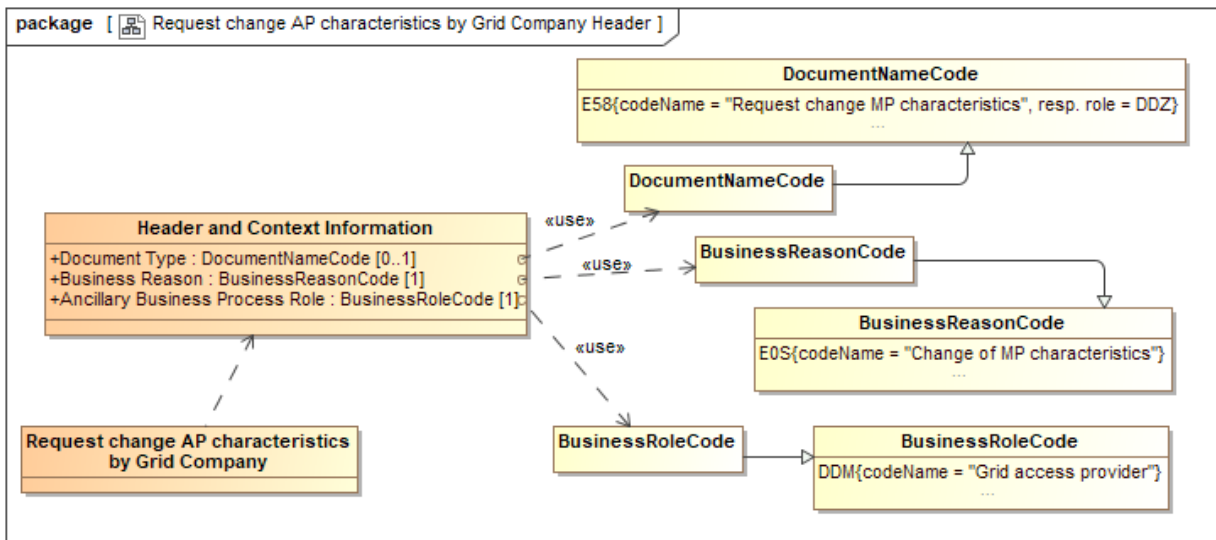

Figure 33 Class diagram: Header and Context information Request change Accounting Point characteristics by Grid Company

### A.9. Confirm request change Accounting Point characteristics by Grid Company

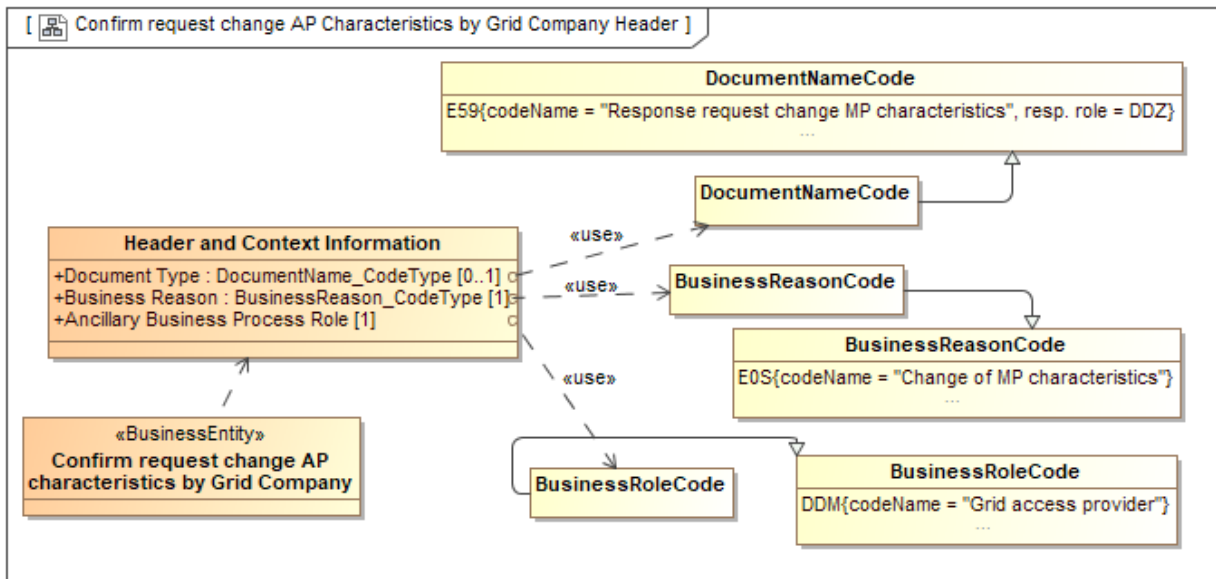

Figure 34 Class diagram: Header and Context information Confirm request change Accounting Point characteristics by Grid Company

### A.10. Reject request change Accounting Point characteristics by Grid Company

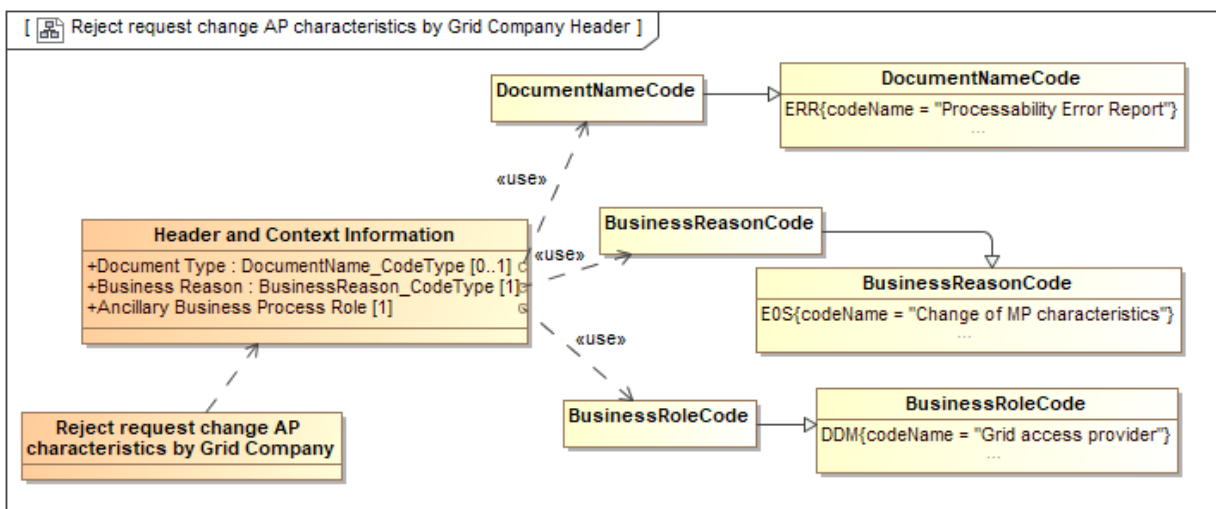

Figure 35 Class diagram: Header and Context information Reject request change Accounting Point characteristics by Grid Company

### A.11. Request change Accounting Point characteristics by Energy Supplier

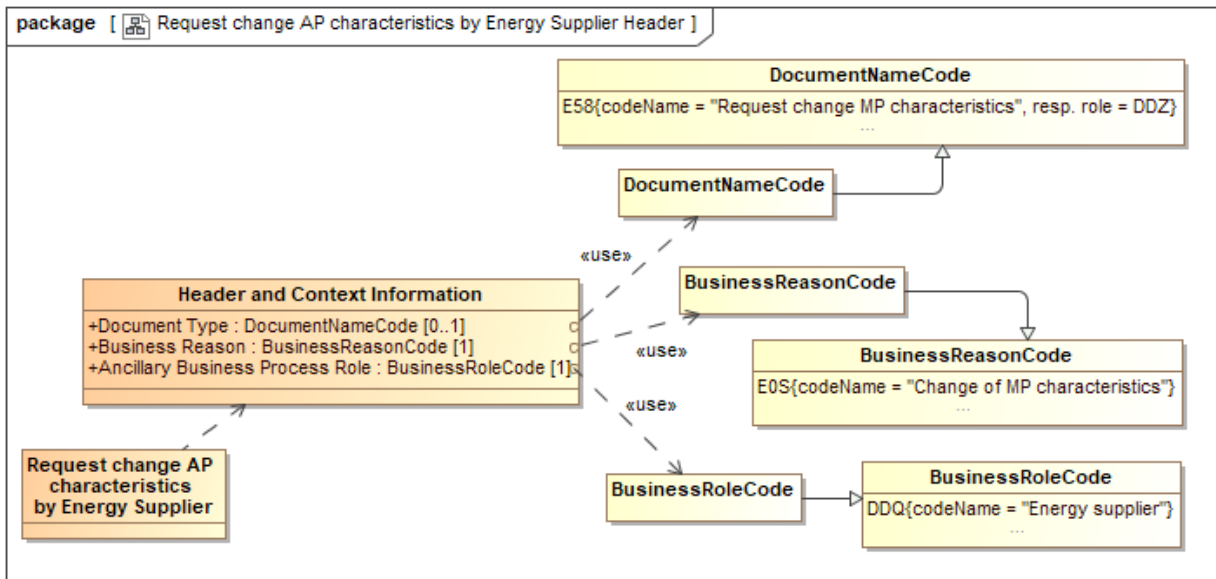

Figure 36 Class diagram: Header and Context information Request change Accounting Point characteristics by Energy Supplier

### A.12. Confirm request change Accounting Point characteristics by Energy Supplier

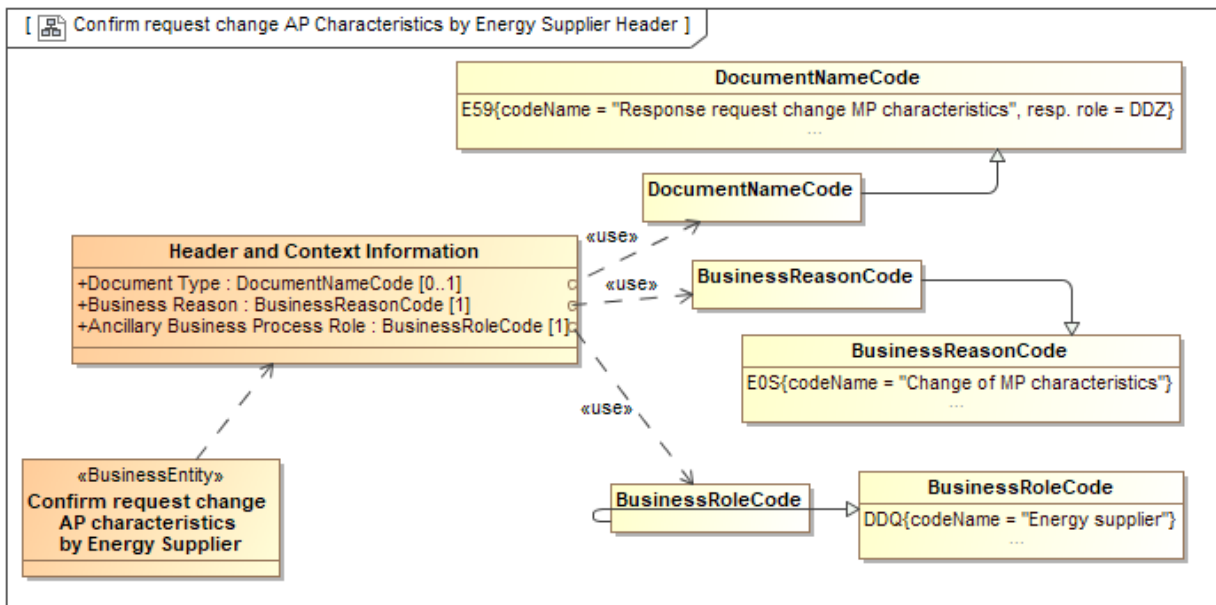

Figure 37 Class diagram: Header and Context information Confirm request change Accounting Point characteristics by Energy Supplier

A.13. Reject request change Accounting Point characteristics by Energy Supplier

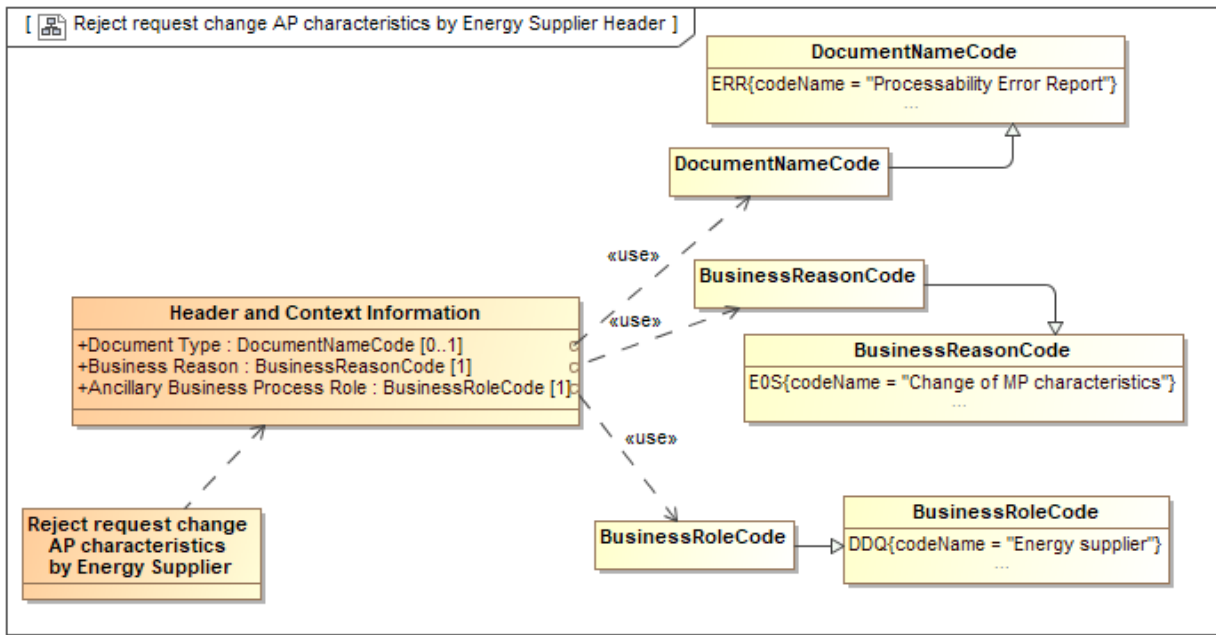

Figure 38 Class diagram: Header and Context information Reject request change Accounting Point characteristics